



# MPPT solar charger manual

BlueSolar MPPT 75/10 up to 100/20

Rev 09 - 02/2025

This manual is also available in [HTML5](#).

# Table of Contents

<b>1. Safety precautions</b>	<b>1</b>
1.1. General safety precautions	1
1.2. Wiring safety precautions	1
1.3. Symbols used on the enclosure	2
1.4. FCC and Industry Canada Compliance	2
<b>2. Introduction</b>	<b>4</b>
2.1. Battery voltage, PV voltage and current rating	4
<b>3. Features</b>	<b>5</b>
3.1. Automatic battery voltage detection	5
3.2. Outstanding MPPT algorithm	5
3.3. Outstanding conversion efficiency	5
3.4. Extensive electronic protection	5
3.5. VictronConnect app	5
3.6. Display	6
3.7. VE.Direct port	6
3.8. Load output	7
3.8.1. Physical load output	7
3.8.2. Virtual load output	8
3.8.3. BatteryLife	8
3.9. Battery charging	8
3.9.1. Adaptive 3-stage battery charging	8
3.9.2. Flexible charge algorithm	9
3.9.3. Equalization charging	9
3.10. Temperature sensing	9
3.10.1. Internal temperature sensor	9
3.10.2. External temperature and voltage sensor	9
3.11. Voltage sensing	10
3.12. Remote on/off	10
3.13. WireBox	10
<b>4. Installation</b>	<b>11</b>
4.1. Mounting	11
4.2. Battery	11
4.3. PV array	11
4.4. Grounding	12
4.5. Connection overview	13
4.6. Electrical connections	13
4.7. Connect the MPPT Control display	14
<b>5. Configuration and settings</b>	<b>15</b>
5.1. How to change settings	15
5.1.1. Settings via the VictronConnect app	15
5.1.2. Settings via the jumper link	16
5.1.3. Settings via MPPT Control display	16
5.2. All settings explained	16
5.2.1. Battery settings	17
5.2.2. Load output settings	22
5.2.3. Streetlight settings	24
5.2.4. TX port settings	27
5.2.5. RX port settings	28
5.3. Updating firmware	29
5.4. VE.Smart Networking	29
5.4.1. VE.Smart Networking setup	30
<b>6. Operation</b>	<b>33</b>
6.1. Start up	33
6.2. Battery charging	33
6.3. Automatic equalization	34
6.4. Lithium batteries	34
6.5. Shutdown and restart procedure	34

6.6. Maintenance procedure .....	35
<b>7. Monitoring .....</b>	<b>36</b>
7.1. LED indications .....	36
7.2. Error codes .....	37
7.3. Monitoring via the VictronConnect app .....	37
7.3.1. VictronConnect app status screen .....	37
7.3.2. VictronConnect app history screen .....	38
7.3.3. VictronConnect app error reporting .....	39
7.4. Monitoring via a GX device and VRM .....	39
<b>8. Troubleshooting .....</b>	<b>41</b>
8.1. Solar charger is damaged .....	41
8.2. Solar charger is unresponsive .....	41
8.3. Solar charger is off .....	42
8.3.1. PV voltage too low .....	42
8.3.2. Settings being edited on an external display .....	43
8.3.3. Disabled in the settings .....	44
8.3.4. Disabled by remote or BMS .....	44
8.3.5. Low lithium battery temperature .....	44
8.4. Solar charger is externally controlled .....	44
8.5. Batteries are not charged .....	44
8.5.1. Battery is full .....	45
8.5.2. Battery not connected .....	45
8.5.3. Reverse battery polarity .....	46
8.5.4. Blown fuse .....	47
8.5.5. Battery settings too low .....	47
8.5.6. PV voltage too high .....	48
8.5.7. Reverse PV polarity .....	48
8.6. Batteries are undercharged .....	49
8.6.1. Insufficient solar supply .....	49
8.6.2. DC load too high .....	49
8.6.3. Battery cable voltage drop .....	50
8.6.4. Temperature compensation setting incorrect .....	51
8.6.5. Temperature difference between solar charger and battery .....	51
8.7. Batteries are overcharged .....	51
8.7.1. Battery voltage setting too high .....	51
8.7.2. Battery charge voltage settings too high .....	52
8.7.3. Battery unable to deal with equalisation .....	52
8.7.4. Battery old, faulty or undersized .....	52
8.8. Solar charger not achieving full output .....	52
8.8.1. PV yield lower than expected .....	53
8.8.2. Maximum output power relates to battery voltage .....	54
8.8.3. Temperature above 40°C .....	54
8.8.4. PV connections burned or melted .....	54
8.9. Communication Issues .....	55
8.9.1. Bluetooth .....	55
8.9.2. VE.Direct port .....	56
8.9.3. VE.Smart Networking .....	56
8.10. Load output issues .....	56
8.10.1. Load output not able to run load .....	57
8.10.2. Incorrect load output current reading .....	57
8.11. Miscellaneous issues .....	57
8.11.1. Only voltage readings, no current or power .....	57
8.11.2. Unable to select 36V or 48V battery voltage .....	58
8.11.3. Unable to operate as a DC-DC charger or power supply .....	58
8.11.4. Interrupted firmware update .....	58
8.11.5. Ground current .....	58
8.12. Error code overview .....	59
8.12.1. Error 1 - Battery temperature too high .....	59
8.12.2. Error 2 - Battery voltage too high .....	59
8.12.3. Error 17 - Solar charger overheated despite reduced output current .....	59
8.12.4. Error 18 - Solar charger over-current .....	59
8.12.5. Error 20 - Maximum bulk time exceeded .....	59
8.12.6. Error 21 - Current sensor issue .....	59
8.12.7. Error 26 - Terminal overheated .....	59
8.12.8. Error 28 - Power stage issue .....	60
8.12.9. Error 33 - PV over voltage .....	60

8.12.10. Error 38, 39 - PV Input shutdown .....	60
8.12.11. Error 40 - PV Input failed to shutdown .....	60
8.12.12. Error 80 to 88 - PV Input shutdown .....	60
8.12.13. Error 116 - Calibration data lost .....	60
8.12.14. Error 117 - Incompatible firmware .....	61
8.12.15. Error 119 - Settings data lost .....	61
<b>9. Technical specifications .....</b>	<b>62</b>
9.1. Specifications 75/10, 75/15, 100/15 and 100/20 .....	62
9.2. Dimension drawings .....	63
9.2.1. Dimensions 75/10 and 75/15 .....	63
9.2.2. Dimensions 100/15 .....	64
9.2.3. Dimensions 100/20 .....	64

# 1. Safety precautions

## 1.1. General safety precautions



- Read this manual carefully. It contains important instructions that need to be followed during installation, operation and maintenance.
- Save these instructions for future reference on operation and maintenance.



- Danger of battery explosion from sparking.
- Danger of electric shock.
- Install the product in a heatproof environment. Ensure therefore that there are no chemicals, plastic parts, curtains or other textiles, etc. in the immediate vicinity of the equipment.
- The product is not allowed to be mounted in a user accessible area.
- Ensure that the equipment is used under the correct operating conditions. Never operate it in a wet environment.
- Never use the product at sites where gas or dust explosions could occur.
- Ensure that there is always sufficient free space around the product for ventilation.
- Refer to the specifications provided by the manufacturer of the battery to ensure that the battery is suitable for use with this product. The battery manufacturer's safety instructions should always be observed.
- Protect the solar modules from incident light during installation, e.g. cover them.
- Never touch uninsulated cable ends.
- Use only insulated tools.
- This product is designed and tested in accordance with international standards. The equipment should be used for the designated application only.
- Connections must always be made in the sequence described in the [Installation \[11\]](#) chapter of this manual.
- The installer of the product must provide a means for cable strain relief to prevent the transmission of stress to the connections.
- In addition to this manual, the system operation or service manual must include a battery maintenance manual applicable to the type of batteries used.

## 1.2. Wiring safety precautions



- Use flexible multi-stranded copper cable for the battery and PV connections.
- The diameter of the individual strand of the cable used should not exceed 0.4mm (0.016 inch) or have a surface area exceeding 0.125mm<sup>2</sup> (AWG26).
- The maximum operating temperature is 90°C (194°F).
- A 25mm<sup>2</sup> cable, for example, should have at least 196 strands (class 5 or higher stranding according to VDE 0295, IEC 60228 and BS6360). An AWG2 gauge cable should have at least 259/26 stranding (259 strands of AWG26). Example of suitable cable: class 5 "Tri-rated" cable (it has three approvals: American (UL), Canadian (CSA) and British (BS)).
- In case of thicker strands the contact area will be too small and the resulting high contact resistance will cause severe overheating, eventually resulting in fire. See below figure for examples of what cable to use and not to use.







**For the 20A model only:**

The grounding terminal is located on the side of the housing and is identified by this symbol: .

### 1.3. Symbols used on the enclosure

The following symbols are used on the solar charger enclosure:

Symbol	Name	Meaning
	Danger of electric shock warning	Do not touch the electric connections, there is danger of electrical shock.
	Hot surface warning	Do not touch the surface of the appliance, while it is running, it will get hot.
	Read the manual instruction	Read the product manual before installation and use.
IP43	Ingress protection value	IP43 - The electronic components are protected from tools and small wires greater than 1 millimetre and protected from water spray less than 60 degrees from vertical.
	Double insulation symbol	The appliance is double insulated and does not require a safety connection to electrical earth (ground).

### 1.4. FCC and Industry Canada Compliance

This device complies with part 15 of the FCC Rules and to RSS of Industry Canada. Operation is subject to the following two conditions:

1. This device may not cause harmful interference, and
2. This device must accept any interference received, including interference that may cause undesired operation.

Le présent appareil est conforme aux CNR d'Industrie Canada applicables aux appareils radio exempts de licence. L'exploitation est autorisée aux deux conditions suivantes : (1) l'appareil ne doit pas produire de brouillage, et (2) l'utilisateur de l'appareil doit accepter tout brouillage radioélectrique subi, même si le brouillage est susceptible d'en compromettre le fonctionnement.

Changes or modifications not expressly approved by the party responsible for compliance could void the user's authority to operate the equipment.

Note: This equipment has been tested and found to comply with the limits for a Class B digital device, pursuant to part 15 of the FCC Rules. These limits are designed to provide reasonable protection against harmful interference in a residential installation. This equipment generates, uses and can radiate radio frequency energy and, if not installed and used in accordance with the instructions, may cause harmful interference to radio communications. However, there is no guarantee that interference will not occur in a particular installation. If this equipment does cause harmful interference to radio or television reception, which can be determined by turning the equipment off and on, the user is encouraged to try to correct the interference by one or more of the following measures:

- Reorient or relocate the receiving antenna.
- Increase the separation between the equipment and receiver.
- Connect the equipment into an outlet on a circuit different from that to which the receiver is connected.
- Consult the dealer or an experienced radio/TV technician for help.

This Class B digital apparatus complies with Canadian ICES-003.

Cet appareil numérique de Classe B est conforme à la norme Canadienne ICES-003.

## 2. Introduction

The Victron Energy BlueSolar charge controller is an ultra fast Maximum Power Point Tracking (MPPT) solar charger with an outstanding conversion efficiency and is suitable for a wide range of battery and PV voltages.

### 2.1. Battery voltage, PV voltage and current rating

The solar charger can charge a lower nominal-voltage battery from a higher nominal voltage PV array. The controller will automatically adjust to the battery voltage and will charge the battery with a current up to its rated current.

The product name of the solar charger incorporates the maximum PV voltage and the maximum battery charge current.

For example: A 75/15 model has a maximum PV voltage of 75V and can charge the battery with a maximum of 15A.

The table below indicates the maximum PV voltage and maximum battery charge current of the solar chargers that are covered by this manual:

Solar charger model	Maximum PV voltage	Maximum battery charge current	Suitable battery voltages
MPPT 75/10	75V	10A	12 and 24V
MPPT 75/15	75V	15A	12 and 24V
MPPT 100/15	100V	15A	12 and 24V
MPPT 100/20	100V	20A	12, 24, 36 and 48V



## 3. Features

### 3.1. Automatic battery voltage detection

The solar charger automatically detects supported (e.g 12V, or 24V) system voltage (battery voltage) on first power up. If a different system voltage is required at a later stage, or if the solar charger is connected to a 36V system, this can be manually configured in the solar charger settings.

### 3.2. Outstanding MPPT algorithm

#### Ultra fast MPP tracking

The solar charger contains an ultra fast MPPT controller. This is especially beneficial when the solar light intensity is constantly changing, as is the case during cloudy weather. Because of the ultra fast MPPT controller, 30% more energy is harvested compared to solar chargers with a PWM controller and up to 10% more compared to slower MPPT controllers.

#### Optimal solar yield

The solar charger has an innovative tracking algorithm. It will always maximize energy harvest by locking to the optimum MPP (Maximum Power Point). If partial shading occurs, two or more maximum power points may be present on the power-voltage curve. Conventional MPPTs tend to lock to a local MPP, which may not be the optimum MPP.

### 3.3. Outstanding conversion efficiency

The solar charger has an outstanding conversion efficiency. The maximum efficiency exceeds 98%. One of the benefits of the high efficiency is that the solar charger does not have a cooling fan and the maximum output current is guaranteed up to an ambient temperature of 40°C (104°F).

### 3.4. Extensive electronic protection

The solar charger is protected against over-temperature. The output is fully rated up to an ambient temperature of 40°C (104°F). Should the temperature further increase, the output current will be derated.

The solar charger is equipped with PV reverse polarity protection and PV reverse current protection.

### 3.5. VictronConnect app

The **VictronConnect app** can be used to:

- Monitor the solar charger and view real-time solar and battery data.
- Operate solar charger features.
- Access up to 30 days of historical data and error history.
- Configure solar charger settings.
- Update firmware.



Screenshot of the VictronConnect app, showing real-time data and historical data.

The VictronConnect app can be downloaded from app stores or from the [Victron Energy downloads page](#).

### The app is available for the following platforms:

- Android.
- Apple iOS, note that USB is not supported, it is only possible to connect via Bluetooth.
- MacOS.
- Windows, note that Bluetooth is not supported, it is only possible to connect via USB.



### The app can connect to the solar charger in the following ways:

- Via Bluetooth, using an optional [VE.Direct Bluetooth Smart Dongle](#).
- Via USB, using an optional [VE.Direct USB interface](#).
- Via internet or LAN, through the [VRM portal](#), using an optional [GX device](#) or [GlobalLink 520](#).

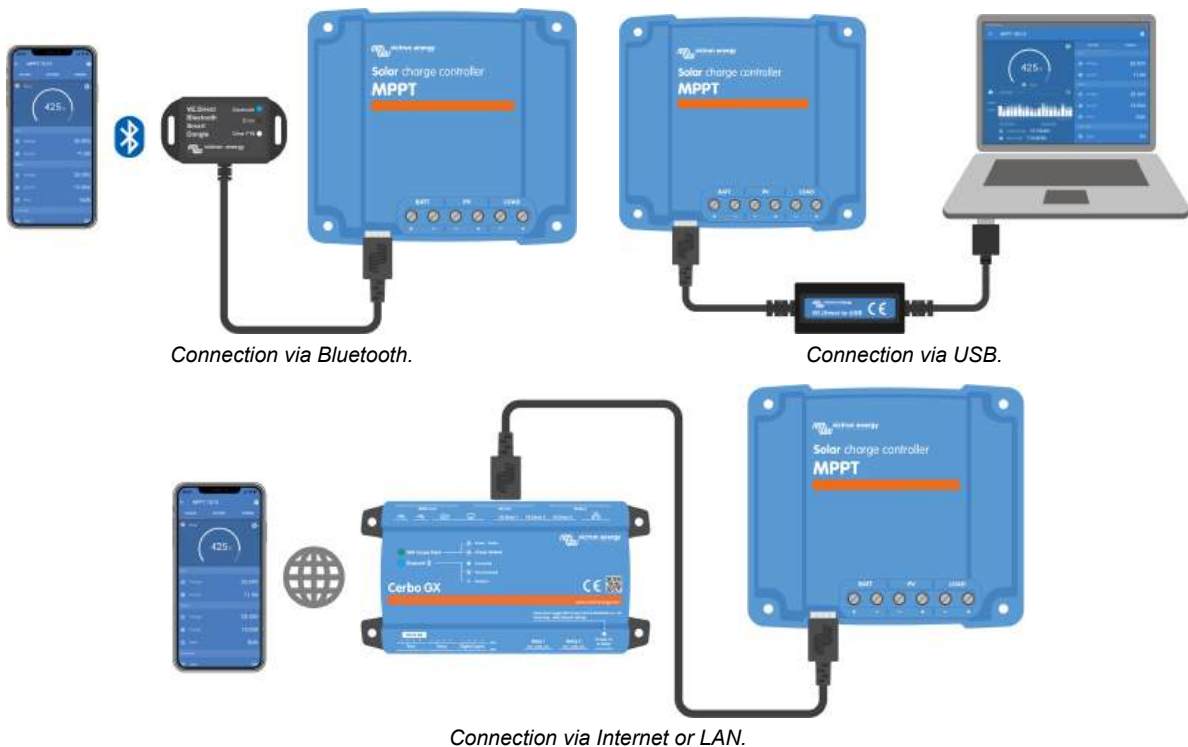

## 3.6. Display

There are a number of display options:

- The [VictronConnect app](#).
- A [GX device](#).
- The [VRM Portal](#), note that a GX device or a [GlobalLink 520](#) is needed.
- The [MPPT Control](#) - an (optional) external display that connects to the VE.Direct port. Note that the required [VE.Direct cable](#) is not included with the MPPT Control.

## 3.7. VE.Direct port

The VE.Direct port is used to communicate with the solar charger. It can be used for several purposes:

- To connect to a monitoring device, such as a GX device or the GlobalLink.
- To connect with the VictronConnect app.
- For external control.
- To program the load output behaviour.

Special cables or interfaces are needed to connect to this port:

- [VE.Direct cable](#) - used to connect to a GX device or the GlobalLink.
- [VE.Direct to USB interface](#) - used to connect via USB to the VictronConnect app.
- [VE.Direct Bluetooth Smart dongle](#) - used to connect via Bluetooth to the VictronConnect app.
- [VE.Direct TX digital output cable](#) - used for streetlight control or to create a virtual load output.
- [VE.Direct non inverting remote on/off cable](#) - used to remotely switch the solar charger on or off.

## 3.8. Load output

The solar charger is equipped with a physical and virtual load output.

### 3.8.1. Physical load output

The DC loads in the system can be connected to the load output terminals. The solar charger controls the load output and disconnects the loads if the battery voltage drops too low, safeguarding the battery against too-deep discharges.

The disconnect voltage of the load output and the battery management algorithm can be configured via a jumper in the VE.Direct port or via the VictronConnect app. For more information refer to the [Load output settings \[22\]](#) chapter.

The current rating of the load output is 15A or 20A (depending on the MPPT model) and is short-circuit proof.



Note that the load output of the MPPT 100/20, when used in a 36 or 48V system, is only rated at 1A.

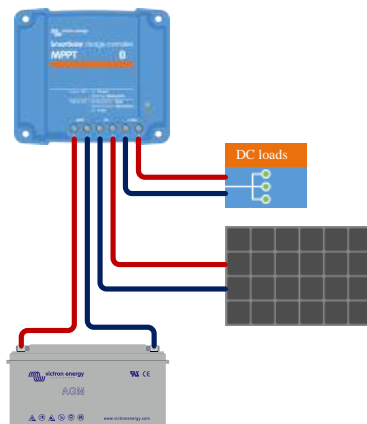

*Solar charger system with DC loads connected to the load output*

Some loads, particularly inverters, have a higher current rating or high start-up current rating, exceeding the load output's capacity. These loads should be connected directly to the battery. The solar charger can still control these loads to prevent deep battery discharges by linking the load's remote on/off terminal to the solar charger load output. Depending on the load's on/off terminal type, a specific interface cable, such as an [Inverting remote on/off cable](#), might be necessary.

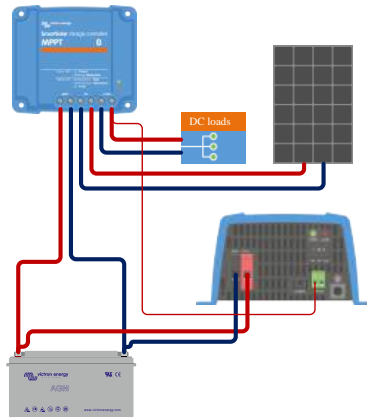

*Solar charger system with inverter connected directly to the battery and controlled by the load output*

Alternatively, a [BatteryProtect](#) can be used to control the load.

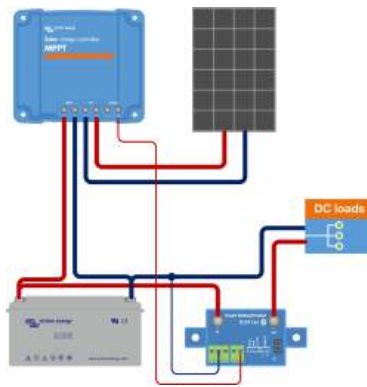

*Solar charger system with DC loads connected directly to the battery via a BatteryProtect controlled by the load output*

### 3.8.2. Virtual load output

A virtual load output can be established to control loads with current ratings greater than the solar charger's load output.

**To create a virtual load output:**

- Use the [VE.Direct TX cable](#) and enable it to act as a virtual load output via the VictronConnect App RX port function. Refer to the [RX port settings \[28\]](#) chapter.

The virtual load output can be set up within the VictronConnect app and controlled using battery voltages or the BatteryLife algorithm. For details on the configuration process, please consult the [Load output settings \[22\]](#) chapter.

### 3.8.3. BatteryLife

When the solar charger is not able to recharge the battery to its full capacity within one day, the result is often that the battery will continually be cycled between a 'partially charged' state and the 'end of discharge' state. This mode of operation (no regular full recharge) will destroy a lead-acid battery within weeks or months.

The BatteryLife algorithm will monitor the state of charge of the battery and, if needed, day by day slightly increase the load disconnect level (i.e. disconnect the load earlier) until the harvested solar energy is sufficient to recharge the battery to nearly the full 100%. From that point onward, the load disconnect level will be modulated so that a nearly 100% recharge is achieved about once every week.

## 3.9. Battery charging

### 3.9.1. Adaptive 3-stage battery charging

The solar charger is a 3-stage charger. The charge stages are: Bulk – Absorption – Float.

#### Bulk

During the bulk stage, the solar charger delivers the maximum charge current, to rapidly charge the batteries. During this stage, the battery voltage will slowly increase. Once the battery voltage has reached the set absorption voltage, the bulk stage stops and the absorption stage commences.

## Absorption

During the absorption stage, the solar charger has switched to constant voltage mode. The current flowing to the battery will gradually decrease. Once the current has dropped below 1A (tail current), the absorption stage stops and the float stage will commence.

When only shallow discharges occur the absorption time is kept short. This is to prevent overcharging of the battery. But if the battery was deeply discharged, the absorption time is automatically increased, to make sure that the battery is fully recharged.

## Float

During the float stage, the voltage is reduced, and the battery's fully charged state is maintained.



A storage stage is not needed for solar chargers, unlike for AC chargers, since at night there is no solar power, so battery charging will stop.

### 3.9.2. Flexible charge algorithm

The VictronConnect app allows selection of 8 pre-set charge algorithms, or alternatively the charge algorithm is fully programmable. The charge voltages, stage duration and the charge current can be customized.

### 3.9.3. Equalization charging

Some lead-acid battery types need a periodic equalization charge. During equalization the charge voltage will be increased above the regular charge voltages to achieve cell balancing.

If an equalization charge is required it can be enabled using the VictronConnect app.

## 3.10. Temperature sensing

Temperature sensing allows for temperature compensated charging. The absorption and float charge voltages are adjusted based on either the battery temperature (accessory needed) or otherwise on the solar charger internal temperature.

Temperature compensated battery charging is needed when charging lead-acid batteries in hot or cold environments.

The temperature compensation can be enabled or disabled in the solar charger settings and the amount of compensation, the compensation coefficient (mV/°C), is adjustable.

### 3.10.1. Internal temperature sensor

The solar charger has a built-in internal temperature sensor.

The internal temperature is used to set the temperature compensated charge voltages. For this, the internal temperature when the solar charger is "cold" is used. The solar charger is "cold" when there is only little current flowing into the battery. Be aware that this is only an estimation of the ambient and the battery temperature. Should a more accurate battery temperature be needed, consider using an external battery temperature sensor, see chapter [External temperature and voltage sensor \[9\]](#).

The temperature compensation range is 6°C to 40°C (39°F to 104°F).

The internal temperature sensor is also used to determine if the solar charger is overheated.

### 3.10.2. External temperature and voltage sensor

The (optional) [Smart Battery Sense](#) is a wireless battery voltage and temperature sensor and can be used with the solar charger. It measures the battery temperature and the battery voltage and sends this via Bluetooth to the solar charger.

The solar charger uses the Smart Battery Sense measurements for:

- Temperature compensated charging using the actual battery temperature, rather than the solar charger's internal temperature. An accurate battery temperature measurement will improve charging efficiency and prolong the life of lead-acid batteries.
- Voltage compensation. The charge voltage is increased to compensate in case there is a voltage drop over the battery cables during high current charging.

The solar charger communicates with the Smart Battery Sense via Bluetooth using a VE.Smart Network. For more detail on the VE.Smart network see the [VE.Smart Networking manual](#).

Alternatively, a VE.Smart Network that measures battery temperature and battery voltage, can also be set up between a solar charger and a [BMV-712 Smart](#) or [SmartShunt](#) battery monitor that has been equipped with a [Temperature sensor for BMV](#), without the need for a Smart Battery Sense.



Note that a VE.Smart Network can only be set up if the solar charger is capable of Bluetooth communication, has Bluetooth enabled or is equipped with a VE.Direct Bluetooth Smart dongle.

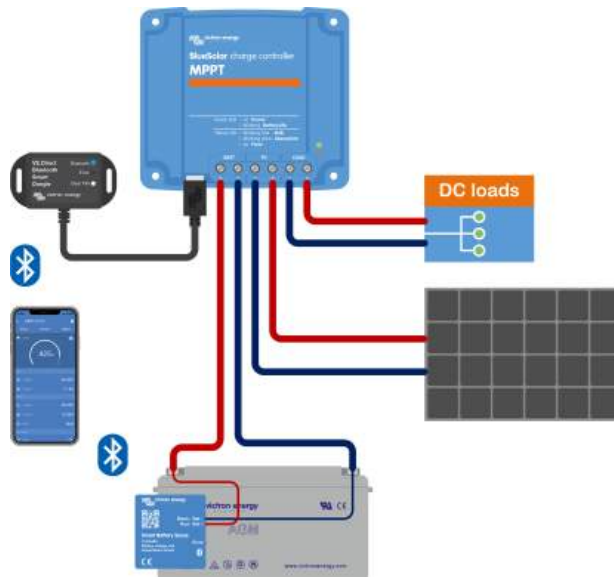

Example of a VE.Smart Network of a Smart Battery Sense and a solar charger.

### 3.11. Voltage sensing

An optional [Smart Battery Sense](#) or [battery monitor](#) measures the battery terminal voltage and sends this via Bluetooth using the [VE.Smart \[29\]](#) network to the solar charger. If the battery voltage is less than the solar charge voltage, the solar charger will increase its charge voltage to compensate for voltage losses.

### 3.12. Remote on/off

A virtual remote on/off terminal can be created by using the (optional) [VE.Direct non inverting remote on/off cable](#).

### 3.13. WireBox

The optional MPPT WireBox is a plastic cover that can be attached to the bottom of the solar charger. It covers the battery and solar terminals, preventing accidental or inquisitive contact with the battery and PV terminals. It provides an extra level of safety, and is particularly useful if the solar charger is installed in a general access area.

For more information and to find the right MPPT WireBox for your solar charger see the [MPPT WireBox product page](#):

- [MPPT WireBox-Tr](#)

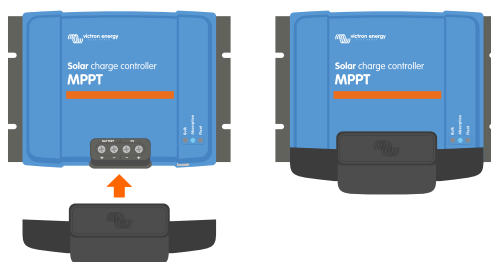

Example of a solar charger with MPPT WireBox

## 4. Installation



The DC (PV) input is not isolated from the battery circuit. Therefore the PV, battery and control circuit are considered hazardous and should not be user accessible.



For proper temperature compensated battery charging the ambient temperature of the solar charger and the battery must be within 5°C (9°F).



The battery and PV connections must be guarded against inadvertent contact. Install the solar charger in an enclosure or install the optional [WireBox \[10\]](#).

### 4.1. Mounting

Mount the solar charger vertically on a non-flammable substrate, with the electrical terminals facing downwards.

The [Dimension drawings \[63\]](#) chapter of this manual contains the dimension drawing of the solar charger, this drawing also indicates the mounting holes.

Observe a minimum clearance of 10cm under and above the solar charger for optimal cooling.

Mount the solar charger within 3 meters from the battery, but never directly above the battery. This is to prevent damage due to gassing of the battery.



Avoid ambient temperature differences of more than 5°C between the solar charger and the battery. These temperature differences can lead to incorrect temperature compensated charging, which can reduce the battery lifetime.

If large temperature differences or extreme ambient temperature conditions are expected, use a direct battery temperature sense source like the Smart Battery Sense or a BMV or SmartShunt equipped with a temperature sensor.

**If the optional MPPT WireBox is used:**

- Affix the steel WireBox base to the solar charger before the solar charger is mounted into its final position.
- For full mounting instructions, see the [MPPT WireBox TR](#) quick installation guide.

### 4.2. Battery

The battery supply must be protected by a fuse as per the below table. This is also the case even if the solar charger has already been equipped with an external fuse.

Solar charger type	Minimum battery fuse rating	Maximum battery fuse rating
MPPT 75/10	15A	20A
MPPT 75/15 and 100/15	20A	25A
MPPT 100/20	25A	30A



For Canada the battery fuse must comply with the C22.2 standards.



The battery installation must be done in accordance with the local storage battery rules. For Canada this is the Canadian Electrical Code, Part I.



Use flexible multi stranded copper cable for the battery connections Also see chapter [Wiring safety precautions \[1\]](#).

### 4.3. PV array

The solar charger can be used with a PV configuration that satisfies both these two conditions:

- The maximum open circuit PV voltage can not exceed 75V or 100V, depending on the solar charger model.

- The nominal PV voltage should be at least 5V higher than the battery voltage.

The PV array can consist of mono- or poly-crystalline panels.

The solar panels are connected in series, in parallel or in series/parallel. See below figure for examples of these configurations.

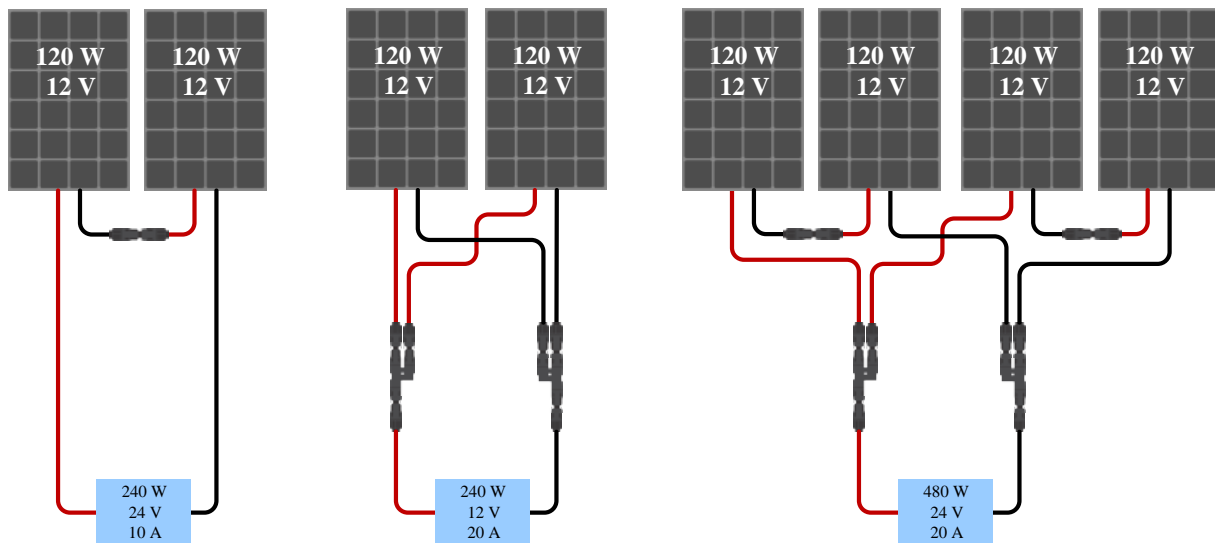

Examples of series, parallel and series/parallel solar arrays.

To help calculate the size of the PV array configuration use the [MPPT sizing calculator](#). Alternatively, use one of these PV array configurations:

PV array example 12V battery with 75V solar charger:

- Minimum number of cells in series: 36 (12V panel).
- Recommended number of cells for highest controller efficiency: 72 (2x 12V panel in series or 1x 24V panel).
- Maximum: 108 cells (3x 12V panel in series).

PV array example 24V battery with 100V solar charger:

- Minimum number of cells in series: 72 (2x 12V panel in series or 1x 24V panel).
- Maximum: 144 cells (4x 12V panel in series).



- Provide a means to disconnect all current-carrying conductors of a photo-voltaic power source from all other conductors in a building or other structure.
- Careful: when calculating the number of panels that can be used in series, make sure to take both its Open circuit voltage (Voc) and its Temperature coefficient into account. At ambient temperatures below 25°C, the Voc will be higher.
- A switch, circuit breaker, or other device, either AC or DC, shall not be installed in a grounded conductor if operation of that switch, circuit breaker, or other device leaves the grounded conductor in an un-grounded state while the system remains energized.
- Do not use solar panels with optimizers. In worst case, the use of optimizers will cause irreparable damage to the solar charger.
- Use flexible multi stranded copper cable for the screw connections . See chapter [Wiring safety precautions \[1\]](#).

## 4.4. Grounding

### Battery grounding

The solar charger can be installed in a positive or in a negative grounded system.

Apply a single ground connection, preferably close to the battery, to prevent system issues or ground loops.

### Chassis grounding (only for the 20A model)

A separate ground path for the chassis ground is permitted because the chassis is isolated from the positive and the negative terminals.



### PV array grounding

The positive and negative of the PV array should not be grounded.

Ground the frame of the PV panels to reduce the impact of lightning.

Do not connect the solar charger to a grounded PV array. Only one ground connection is allowed, and this should be near the battery.

### Ground fault detection

The system electrical negative should be bonded through a GFDI to earth ground at one (and only one) location.



**WARNING:** When a ground fault is indicated, battery terminals and connected circuits may be ungrounded and hazardous.

## 4.5. Connection overview

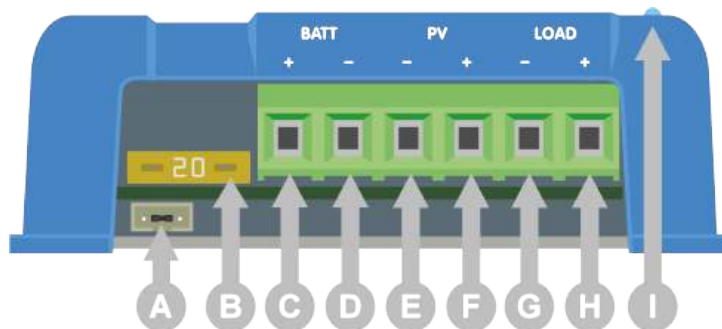

ID	Description
A	VE.Direct socket with jumper link.
B	Fuse.
C	Battery positive (+) screw terminal.
D	Battery negative (-) screw terminal.
E	PV negative (-) screw terminal.
F	PV positive screw (+) terminal.
G	Load negative (-) screw terminal.
H	Load positive screw (+) terminal.
I	LEDs.

## 4.6. Electrical connections



**WARNING:** Check the polarity before connecting the battery and PV voltage.

**WARNING:** Follow the correct installation procedure described in this chapter.

**IMPORTANT:** Torque the battery, load and PV connections at 0.75Nm.

Connection order electrical connections:

1. **Connect the battery:** allow the solar charger to automatically recognise the system voltage (wait 10 seconds).
2. **It is recommended to verify system voltage:** use VictronConnect or an external control display.
3. **Connect the DC loads.**
4. **Connect the PV.**
5. **If applicable, connect the VE.Direct port.**

The correct connection order is necessary to allow the automatic system voltage detection to setup properly. It is only allowed to connect PV first when the system voltage is manually set before connecting the battery. Not following the correct procedures can disable or damage the charger and/or the installation.

See the below figure on how the basic electrical connections are made:

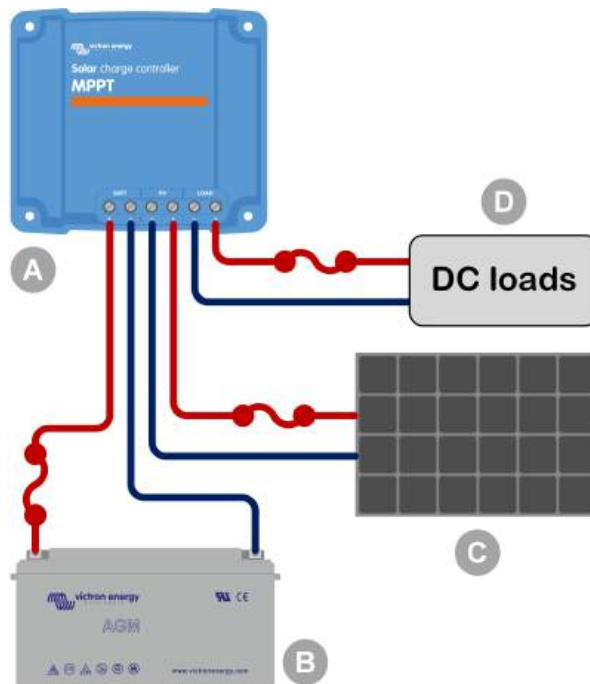

ID	Description
A	Solar charger.
B	Battery or battery bank, lead acid or lithium.
C	Solar panel or solar panel array.
D	DC loads.
	DC fuse.

#### 4.7. Connect the MPPT Control display

Connect the (optional) [MPPT Control](#) display to the VE.Direct port of the solar charger using a [VE.Direct cable](#).

The VE.Direct cable is available in a variety of lengths and is not included with the MPPT control display. Note that it is not possible to extend the VE.Direct cable, the maximum length can not exceed 10 meters.

For more information, see the [MPPT Control manual](#).



Connect the display to the solar charger via a VE.Direct cable

## 5. Configuration and settings

The solar charger settings can be configured so it can be tailored specifically for the system it is used in.



Do not change solar charger settings unless you know what they are and what the effect of changing these settings is going to be.

Incorrect settings may cause system problems including damage to batteries. When in doubt, seek advice from an experienced Victron Energy installer, dealer or distributor.

### 5.1. How to change settings

There are several methods that can be used to change these settings. Some of these allow all settings to be configured, but others might have limitations:

- The VictronConnect app - All settings can be changed and the firmware can be updated.
- The jumper link in the VE.Direct port - The Load output algorithm can be selected.
- The MPPT Control display (optional) - Most settings can be changed.



Do not change solar charger settings unless you know what they are and what the effect of changing these settings can be. Incorrect settings may cause system problems including damage to batteries. When in doubt, seek advice from an experienced Victron Energy installer, dealer or distributor.

#### 5.1.1. Settings via the VictronConnect app

The VictronConnect app can be used to change all solar charger settings and can be used to update the firmware.

See the [VictronConnect app \[5\]](#) chapter for an overview of the different ways the VictronConnect app can connect to the solar charger.

This manual only covers the VictronConnect app solar charger-specific items. For more general information on the VictronConnect app, like how to use it or how to connect, see the [VictronConnect manual](#).

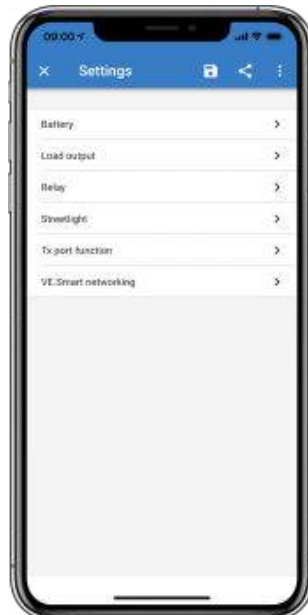

To access the solar charger settings, navigate to the settings page. Do this by clicking on the cog icon  at the top right of the home screen.

The settings page provides access to view and/or to change the solar charger settings.

For information about each setting and how to update firmware see the [Updating firmware \[29\]](#) chapter.





### 5.1.2. Settings via the jumper link

**i** If the load output algorithm is configured via VictronConnect or the MPPT Control display the jumper link is not used and it needs to be removed. Configuration via the jumper link is only needed in case the load output algorithm cannot be configured by any other means.

**i** If the VE.Direct port is going to be used for communication with a GX device, MPPT display or other equipment, the jumper needs to be removed, and cannot be used anymore for load output configuration. If this is the case, configure the load output by using the VictronConnect App or a display. See chapter [Load output settings \[22\]](#) or [Settings via MPPT Control display \[16\]](#) for more information.

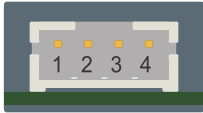
The load output algorithm can be configured via a jumper link, located in the VE.Direct connector:

- If VictronConnect or the MPPT Control display is used to configure the load output algorithm, the jumper link is not used. Remove the jumper.
- If the jumper link is used, see the table below for the load output algorithm belonging to each jumper placement. Should the VictronConnect App or display be used at a later stage to change the load output setting, the jumper link needs to be removed beforehand.

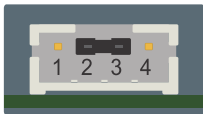
Load output algorithm	Jumper link placement	VE.Direct port 75V models	VE.Direct port 100V models
BatteryLife algorithm Alternatively, the load output algorithm has been set via the VictronConnect App.	No jumper link		
Conventional algorithm low voltage disconnect: 11.1V Automatic load reconnect voltage: 13.1V	Between pin 1 and 2		
Conventional algorithm: low voltage disconnect: 11.8V Automatic load reconnect voltage: 14.0V	Between pin 2 and 3		

The listed voltage values in this table are for 12V battery systems. For 24V and 48V battery systems multiply the listed 12V values by respectively 2 and 4.

### 5.1.3. Settings via MPPT Control display

The optional [MPPT Control](#) display can be used to configure solar charger settings, with the exception of advanced settings such as RX and TX port settings. For information on how to do this see the [MPPT Control manual](#).



The MPPT Control

## 5.2. All settings explained

This chapter lists all solar charger settings that are user-configurable and also explains how to update firmware of the solar charger.

**⚠** Do not change settings unless you know what they are and what the effect of changing these settings will be. Incorrect settings may cause system problems including damage to batteries. When in doubt, seek advice from an experienced Victron Energy installer, dealer or distributor.

### 5.2.1. Battery settings

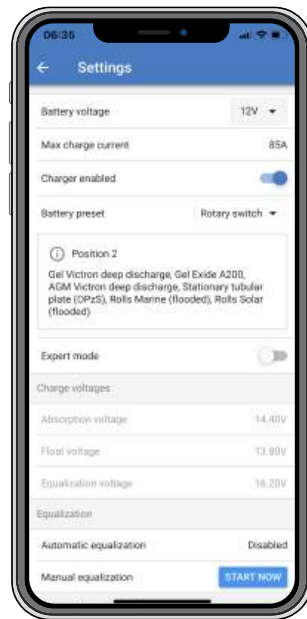

#### Battery voltage

The battery voltage is automatically detected at the very first power-up of the solar charger and the battery voltage is set accordingly. Further automatic detection is disabled. To make sure that a stable measurement is used, the charger first waits 10 seconds, and thereafter takes an averaged measurement. Note that the solar charger will remain off during this time.

In case the solar charger does not measure a battery voltage, it will default to 12V and store that. This will happen if the solar charger is powered via its PV terminals, while not connected to a battery.

Note that the solar charger will not automatically detect a 36V battery. This will need to be set manually.

After automatic detection has taken place, the battery voltage can be changed and set to 12, 24, 36 or 48V, if so required (36V and 48V setting is only possible for the 100/20 model).



#### Tip:

If the firmware of the solar charger needs to be updated, while keeping the automatic voltage detection active, for example before shipping the unit to an end-user, do the following:

- Update the firmware.
- Once the firmware update is complete, go to the settings page in the VictronConnect app.
- On the settings page, click on the three vertical dots in the upper right corner and select "Reset to defaults" from the drop-down menu.
- Un-power the solar charger within 10 seconds.

The next time that the unit is powered up, it will perform the initial automatic voltage detection.

#### Max charge current

This setting sets the maximum battery charge current. It is by default set to the maximum solar charge current.

Use this setting to reduce the charge current, for example, when a smaller battery bank is used that requires a lower charge current.

#### Charger enabled

This setting enables or disables the battery charger. It is by default set to "enabled".

This setting can be used when work needs to be carried out on the installation. When this setting is disabled, the batteries will not be charged.

#### Battery preset

This setting sets the battery charge algorithm.

A selection can be made between:

- Pre-defined factory battery presets.
- User-defined battery presets.
- Create, modify or delete a user-defined preset.

This setting uses factory pre-defined presets for a large variety of battery types. These pre-defined charge algorithms are suitable for almost all installations.

It is possible to also create user-defined battery presets. The chapter [Customize battery charge algorithm \[18\]](#) explains how to do this. These user-defined presets are stored in the VictronConnect app library. This is helpful in case multiple solar chargers need to be configured, eliminating the need to define the entire charge algorithm each time a new solar charger is configured.

### Expert mode

This setting enables or disables expert mode. It is by default set to "disabled".



The default charge algorithms work well for almost all installations. Only enable expert settings if your equipment has special requirements.

When this setting is enabled the following parameters can be configured:

- Charger voltages: bulk, absorption and float.
- Bulk: re-bulk voltage offset.
- Absorption: duration, time and tail current.
- Equalization: current, interval, stop mode and duration.
- Temperature voltage compensation.
- Low temperature cut off.

For the meaning of these parameters see chapter [Battery charge algorithm settings \[20\]](#).

### Equalization



Equalization can cause damage to the battery if the battery is not suitable for an equalization charge. Always check with the battery manufacturer prior to enabling equalization.

This setting can be used to disable or enable automatic equalization. When enabled, the number of days can be selected when equalization should repeat.

A manual equalization can be initiated by pressing the "START NOW" button. Use the manual equalize option only during absorption and float charge stages, and when there is sufficient sunlight. The current and voltage limits are identical to the automatic equalize function. The manual equalization stage lasts 1 hour and can be stopped at any time by the Stop Equalize.



The equalization setting might not be active, this can be the case if the battery preset does not support an equalization charge which is the case with lithium batteries.

### Customize battery charge algorithm

This chapter explains how to modify a battery charge algorithm or to create, modify and delete user defined battery presets. See the [Battery charge algorithm settings \[20\]](#) chapter for the meaning of all charge algorithm parameters.

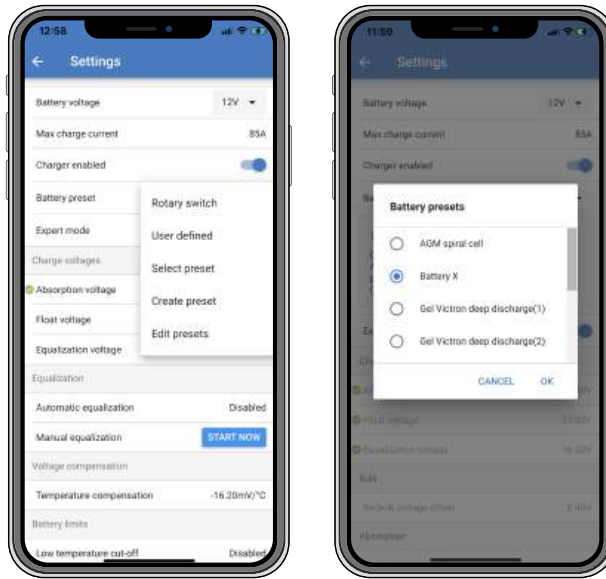

Only experienced users should configure or edit user defined battery charge algorithms. A wrongly defined battery charge algorithm can lead to battery damage or create unsafe situations.

#### To Modify a basic battery charge algorithm:

- Select a preset battery type that is the best match to your battery type.
- Change one of the basic charge parameters that are listed on the settings screen.
- Configure the required parameters.
- The battery preset is now set to "user defined".

#### To Modify an expert battery charge algorithm

- Enable "Expert" mode.
- The basic and additional charge parameters are now listed on the screen.
- Configure the required parameters.
- The battery preset is now set to "user defined".

#### To create and save a custom battery type:

- Select a preset battery type that is the best match to your battery type.
- Change the charge parameters so they match your battery. This can be done either in normal mode or in expert mode.
- The battery preset is now set to "user defined".
- Select in the "Battery preset" menu "Create preset".
- Give the preset battery a name.

#### To load a custom battery type:

- Select in the "Battery preset" menu "Select preset".
- The menu lists all factory preset and custom battery types that were previously added (if any).
- Select the battery type of your choice.

#### To modify (or delete) a custom battery type:

- Select in the "Battery preset" menu "Edit presets"
- Navigate to the battery you want to modify. It is not possible to modify a factory preset, only custom types can be modified (or deleted).
- Modify the charge parameters.

- To save the settings press the "SAVE CHANGES" button at the bottom of the page.
- To delete the battery, press the "REMOVE PRESET" button.

**Battery charge algorithm settings**

This chapter explains all parameters that are used in "Expert" mode and the settings that are used when programming a custom battery type via the battery preset menu.

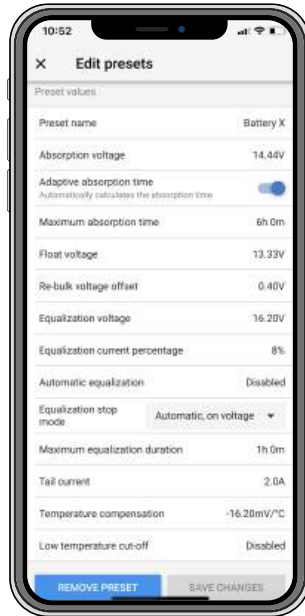

**Absorption voltage**

This setting sets the absorption voltage.

**Adaptive absorption time**

This setting enables or disables the adaptive absorption time.

- **When disabled:** The length of the absorption stage is the same each day, the length is determined by the "Maximum absorption time" setting, provided there is enough solar power.

Be aware that this option can potentially result in overcharging your batteries, especially for lead batteries and if only shallow daily discharges take place. Check with the battery manufacturer for the recommended maximum absorption time.

The only condition that can end the absorption time before the maximum time has been reached, is the "tail current" setting. If the absorption time always needs to be the same length, then disable the "Tail current" setting. See more information on the tail current setting further down in this chapter.

- **When enabled:** The length of the absorption stage is different each day, it adapts itself to the state of charge of the battery in the morning at the beginning of the charge cycle.

The maximum "adaptive" absorption time for the day is determined by the battery voltage as measured just before the solar charger begins operation each morning.

Multiplier	x 1	x 2/3	x 1/3	x 1/6
<b>Adaptive absorption time *</b>	6:00 hours	4:00 hours	2:00 hours	1:00 hour
<b>12V system</b>	$V_{batt} < 11.9V$	$11.9V < V_{batt} < 12.2V$	$12.2V < V_{batt} < 12.6V$	$V_{batt} > 12.6V$
<b>24V system</b>	$V_{batt} < 23.8$	$23.8 < V_{batt} < 24.2V$	$24.2V < V_{batt} < 25.2V$	$V_{batt} > 25.2V$
<b>48V system</b>	$V_{batt} < 47.6$	$47.6V < V_{batt} < 48.8V$	$48.8V < V_{batt} < 50.4V$	$V_{batt} > 50.4$

\*) The adaptive absorption time is calculated by the multiplier times the "Maximum absorption time" setting. The adaptive absorption times in this table are based on the 6 hour default "Maximum absorption time" setting.

**Maximum absorption time**

This setting sets the absorption time limit. This setting is only available when programming a custom charge profile.



Enter the maximum time in hours and minutes (hh:mm) the solar charger is allowed to spend in the absorption stage. The maximum time that can be set is 12 hours and 59 minutes.

#### Float voltage

This setting sets the float voltage.

#### Re-bulk voltage offset

This setting sets the re-bulk voltage offset. This offset voltage is used to determine when a charge stage stops and the bulk stage starts again, i.e. the charge cycle resets and starts at the first charge stage again.

The re-bulk voltage is calculated by adding the re-bulk voltage offset to the lowest voltage setting (normally this is the float stage).

An example: If the re-bulk offset is set at 0.1V and the float voltage at 13.8V, the charge cycle will restart once the battery voltage drops below 13.7V (13.8 minus 0.1) for one minute.

#### Equalization voltage

This setting set the equalization voltage.

#### Equalization current percentage

This setting sets the percentage of the "maximum charge current" setting that will be used to calculate the equalization charge current.

For example: If the "maximum charge current" setting is set at 10A and the "Equalization current percentage" setting is set to 10%, the Equalization current will be 1A (10% of 10A).

#### Automatic equalization

This setting sets the repeat interval when the equalization stage should take place. This can be set between 1 and 250 days. Setting to 1 means a daily equalization, 2 means every other day and so on.

An equalization stage is typically used to balance the cells and also to prevent stratification of the electrolyte in flooded lead-acid batteries. If equalization is needed or not depends on the type of battery if (automatic) equalization is needed and under what conditions. Check with the battery supplier to find out if equalization is needed for the battery.

During the equalization stage, the charge voltage increases up to the set "Equalization voltage". This is maintained as long as the charge current stays below the "equalization current percentage" setting of the "Maximum current" setting.

Duration of the Automatic equalization cycle:

- For all VRLA battery presets and for some flooded battery presets, the automatic equalization stage ends when the voltage limit (maxV) has been reached.
- For the lithium battery preset, equalization is not available.
- When an automatic equalization stage has not been completed within one day, it will not resume the next day. The next equalization surge will take place according to the interval as set in the "Auto Equalization" setting.

#### Equalisation stop mode

This setting determines when the equalisation stage should end:

- **Automatic:** Equalization stops if the battery voltage has reached the equalisation voltage.
- **Fixed time:** Equalization stops when the time has reached the time as set in the "Maximum equalization duration" setting.

#### Maximum equalization duration

This setting sets the maximum time that the equalization stage will last.

#### Manual equalization

Use this to perform a "once-off" equalization. Once the "start now" button is pressed, a one-hour equalization cycle will be performed, alternatively, the equalization stage can be stopped manually.

#### Tail current

This setting sets the current threshold to end the absorption stage before the maximum absorption time has been reached. If the charge current drops below the set tail current, for one minute, the absorption stage will end and the float stage will start. This setting can be disabled by setting it to zero.

#### Temperature compensation

This setting sets the temperature compensation coefficient that is needed for temperature compensated charging.

Many battery types require a lower charge voltage in warm operating conditions and a higher charge voltage in cold operating conditions. The configured coefficient is in mV per degree Celsius for the whole battery bank, not per cell. The base temperature for the compensation is 25°C (77°F).

The chart below indicates the absorption and float charge voltage behaviour at different temperatures. The graph displays the temperature compensation for a 12V system and uses a  $-16\text{mV}/^\circ\text{C}$  temperature compensation coefficient. For a 48V system multiply by 4.

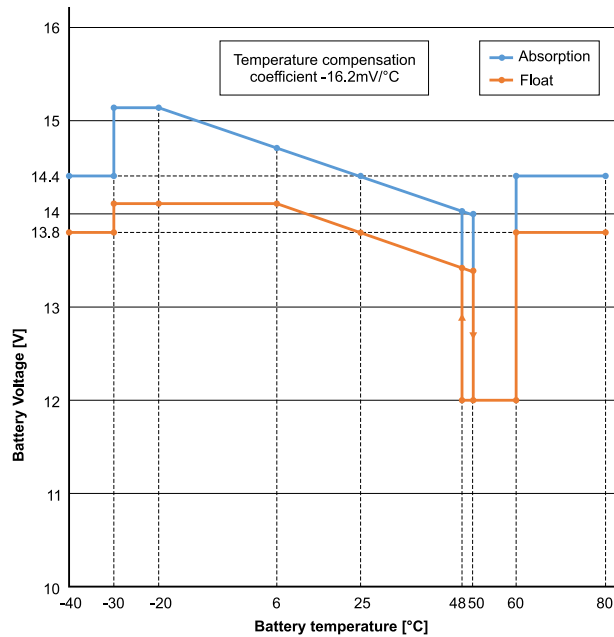

Temperature compensated charge graph

By default, the solar charger uses its internal temperature for battery temperature compensated charging. An internal temperature reading is taken in the morning and then again when the solar charger has been idle for at least one hour, for example when the charger is not actively charging a battery or supplying a load.

When the solar charger is part of VE.Smart Networking and receives a battery temperature reading from a Battery Sense or a battery monitor with a temperature sensor, the actual battery temperature will be used for temperature compensated charging throughout the day.

### Low temperature cut-off

This setting is used to prevent damage to a lithium battery by disabling charging at low temperatures.



The "Low temperature cut-off" feature is only active when the solar charger is part of a VE.Smart network and is receiving a battery temperature reading from a Battery Sense or a battery monitor with temperature sensor.

The "low temperature cut-off" setting is by default disabled. When enabled, a low cut off temperature can be set. The default temperature is  $5^\circ\text{C}$ , this is a suitable temperature setting for lithium iron phosphate (LFP) batteries. However, always check with the lithium battery supplier to find out what this temperature should be set at.

The "low temperature cut-off" mechanism will stop battery charging when the battery temperature has dropped below the low temperature cut-off setting. Battery charging will resume once the battery temperature has risen  $0.5^\circ\text{C}$  above the low temperature cut-off setting.

Note that setting "low temperature cut-off" is not needed for Victron Lithium Smart batteries or for Victron Super Pack batteries with serial number HQ2040 and above. This setting is only needed for lithium batteries that are unable to block charging when the temperature drops too low.

### 5.2.2. Load output settings

These settings are typically used to drive the load output.

The load output settings can also be used to control the VE.Direct TX port [27] enabling it to operate a BatteryProtect, a relay or another load-shedding device. For more information, see the chapter TX port settings [27].



Make sure that the jumper link [16] is removed before configuring the load output. The jumper link should remain removed thereafter. If the jumper is not removed, and the TX port [27] is configured as "normal communication" and/or the RX port [28] is configured as "load output config" (these are the default settings), the jumper will override the VictronConnect load output settings.

Be aware that the load output behaviour will be different than expected when the streetlight setting [24] is enabled (disabled by default).

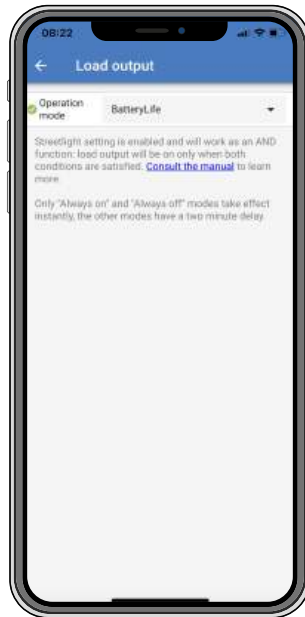

**The available operation modes are:**

- **BatteryLife (default setting):**

This algorithm is self-adapting and aims to maximise the battery's lifespan. For a detailed explanation of its functionality, please refer to the [BatteryLife \[8\]](#) chapter for a description of its functionality.

- **Conventional algorithm 1:**

12V system: OFF when  $V_{batt} < 11.1V$ , ON when  $V_{batt} > 13.1V$ .

24V system: OFF when  $V_{batt} < 22.2V$ , ON when  $V_{batt} > 26.2V$ .

48V system: OFF when  $V_{batt} < 44.4V$ , ON when  $V_{batt} > 52.4V$ .

- **Conventional algorithm 2:**

12V system: OFF when  $V_{batt} < 11.8V$ , ON when  $V_{batt} > 14.0V$ .

24V system: OFF when  $V_{batt} < 23.6V$ , ON when  $V_{batt} > 28.0V$ .

48V system: OFF when  $V_{batt} < 47.4V$ , ON when  $V_{batt} > 56.0V$ .

- **Always off:**

The load output is always OFF.

- **Always on:**

The load output is always ON.

- **User defined algorithm 1:**

OFF when  $V_{batt} < V_{low}$ .

ON when  $V_{batt} > V_{high}$ .

- **User defined algorithm 2:**

OFF when  $V_{batt} < V_{low}$  or  $V_{batt} > V_{high}$ .

ON when  $V_{batt}$  is between  $V_{low}$  and  $V_{high}$ .

- **Automatic Energy Selector (AES):**

ON when  $V_{bat} > V_{high}$ .

OFF when  $V_{bat} < V_{high}$  for the pre-selected AES time.

OFF when  $V_{bat} < V_{low}$ .



Note that the AES timer only runs when Vbat is below Vhigh, but is reset when Vbat goes above Vhigh.

For example: Let's say that the load is configured to turn on when the battery is at 14V (Vhigh) and to turn off at 10V (Vlow):

- If the battery is kept above 14V, the load will never turn off, as the AES timer is continuously reset.
- If the battery is below 14V, the AES timer counts down and the load will turn off once the AES timer expires.
- If the battery drops below 10V, the load will turn off regardless of the state of the AES timer.

The "always off" and the "always on" modes will respond immediately. The other modes have a 2-minute delay before the load output changes. This is so that the solar charger does not respond too quickly when, for example, an inrush current briefly lowers the battery voltage below the threshold.

The [streetlight \[24\]](#) algorithm can also control the load output. The load output is off when the battery voltage is below the load disconnect voltage or when streetlight dimming is at 0%. The load output turns back on when the battery voltage is above the load reconnect voltage and streetlight dimming is between 1 and 100%.

### 5.2.3. Streetlight settings

The streetlight function enables the solar charger to automatically control night lighting. It will automatically determine when the light should be on or off and can control the light intensity.

When the streetlight function is enabled a timer program can be created whereby Sunset, Sunrise as well as Midnight can be used as anchor points for the timer program. These anchor points will automatically adjust depending on length of the night as this changes with the seasons.

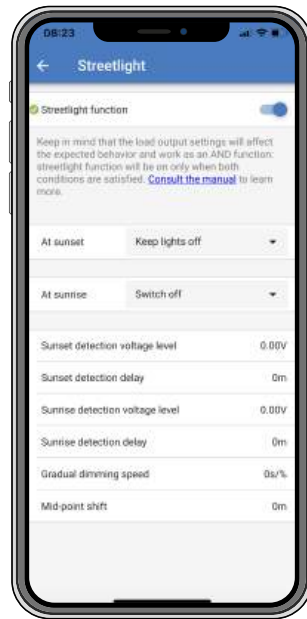

#### Streetlight control

The solar charger controls the streetlight:

- Via the load output terminals.
- Via the TX port together with a [VE.Direct TX digital output cable](#). Also see the [TX port settings \[27\]](#) chapter for more details.



The streetlight algorithm is always applied in conjunction with the settings as configured in the Load output menu:

- If the streetlight is disabled, then the (virtual) load output is controlled only by the configuration as made in the load output menu.
- If streetlight is enabled, then it's an AND function: the load output will be on when both the conditions made in the Load output menu are satisfied as well as the streetlight settings. Otherwise, it's off.

Make sure that load output setting is set to "Always on" or to "BatteryLife". Do not set it to "Always off" as this will result in the light being always off.

For more configurable voltage levels to force the light off, the other load output options can also be used.

### Setting the Sunset action

At sunset you can choose any of the following actions:

- **Keep the lights off**

- **Switch on for a fixed time:**

This option will turn the light on at sunset, and then off again after a configurable interval. When the dimming feature is enabled<sup>1</sup> (1), two dim-levels can be entered: one for the "on" period; and a second for the "off" period. A typical use case for these options is to get a strong light during high traffic hours (right after sunset), and lower intensity during the low hours, to save the battery. Set the second dim level to 0% to switch the light completely off during that second section.

- **Switch on till midnight:**

This option turns the light on at sunset, and then off again at midnight. When the dimming feature is enabled<sup>1</sup>, two dim-levels can be entered: one for the "on" period (up to midnight) and a second dim-level for the "off" period after midnight. Set the second dim level to 0% to switch the light completely off during that second section.

- **Switch on till sunrise:**

This options turns the light on at sunset, and then off again at sunrise. When this option is selected; there is no need to also select an action at sunrise, so the sunrise control option is not needed. When the dimming feature is enabled<sup>1</sup>, only one dim level can be configured, the dim level at sunset.

<sup>1</sup>) The dimming feature requires the TX Port function to be configured to one of the "Light dimming" settings. This so the TX port outputs a PWM signal that can be used to dim the light. If the TX port function has not been set to one of the "Light dimming" settings, the dimming options will not appear in the sunset settings menu. Also see the [TX port settings \[27\]](#) chapter.

### Setting the Sunrise action

At sunrise you can choose to:

- **Switch off:**

Turns the light off at sunrise.

- **Switch on before sunrise:**

This option switches the light on at a configurable time interval before sunrise, and then switches the light off at sunrise.

In case the dimming feature is enabled<sup>1</sup> an interval of more intense light can be configured during early morning rush hour.

Together with the Sunset action, you can now configure three dim levels: one for the sunset rush hours, one during the low traffic hours, and the third for the early morning rush hours.

### Midnight

The charger has no real time clock, and therefore does not know when it is 12 o'clock at night. All references to midnight refer to what we call solar midnight, this is the mid-point between sunset and sunrise.

### Midnight and Sunrise synchronisation

The solar charger needs to have its internal clock synchronised with the solar cycle so it can set the solar midnight and sunrise anchor points in the timer program.

After the streetlight settings have been programmed and the solar charger is powered up, the solar charger will start unsynchronised. It will first assume that midnight is 6 hours after sunset, and that the full night last for 12 hours.

Once in operation, the solar charger will check the time between each detected sunrise. After three full day/night cycles, where the detected time is approximately 24 hours (one hour of deviation is allowed), it will start using its internal clock, instead of the fixed 6 and 12 hour timing.



A loss of power (no battery power together with no PV power) will cause the solar charger to loose its synchronisation. It will take 5 days before it is re-synchronised. Note that the streetlight configuration settings and all other settings will never be lost, they are stored in a non-volatile memory.

### Sunset and sunrise detection

The sunset and sunrise detection voltage settings can be used to adjust the detection to match the panel configuration. The sunrise detection voltage must be 0.5V higher than the sunset detection level. The lowest detectable voltage is 11.4V. Set this option to 0 to use the built-in defaults, which are:

- Sunset =  $V_{\text{panel}} < 11.4V$ .

- Sunrise =  $V_{\text{panel}} > 11.9V$ .

The default setting is 0, which uses built-in default voltages.

Use the "Delay" periods to avoid the system making an accidental switch when clouds pass over the panels. The valid range is between 0 and 60 minutes. The "Delays" are disabled by default (0).

### Gradual dimming speed

The gradual dimming option can be used to slow down the response of the timer program. This is useful when multiple streetlights are used in a row. This helps to mask the fact that each timer uses its own detection and will have a transition moment which will vary from unit to unit.

The dimming settings can be adjusted. You can input the number of seconds required to achieve each percentage-point of change (x seconds/per 1% of dimming). A number from 0 to 100 can be entered. Two examples:

- 0 = immediate response (gradual dimming disabled):

A setting of 0 will achieve an immediate response, this effective means that the gradual dimming option is disabled.

- 9 = dim from 0 to 100% in 15 minutes:

Setting the dimming speed to 9, for example, slows down the dimming speed to 15 minutes (9 seconds for each percentage point of dimming x 100 percentage points = 900 seconds = 15 minutes).



Make sure that the TX port function is set to "Light dimming" mode (as described in point <sup>1</sup> at the beginning of this chapter) and connect a VE.Direct TX digital output cable to the PWM dim input of your LED driver.

### Mid-point shift

The time of midnight is estimated based on solar activity, and depends on your geographical location. Daylight saving times can cause a further deviation between the "solar" and the "clock" midnight. The Mid-point shift function will compensate for these differences. Use 0 to disable the shift (default).



The Mid-point shift setting is only relevant when your streetlight setting program uses "Midnight" as a switching moment.

### Calculation Example:

For calculation we use a day of 1440 minutes, where Sunset is at 19:00 (1140 minutes) and Sunrise is at 6:25 (385 minutes):

- The night duration in minutes is:  $1440m^{(min/day)} - 1140m^{(time\ to\ sunset)} + 385m^{(time\ to\ sunrise)} = 685m$ .
- The degree of shift =  $time\ of\ sunset^{(minutes)} + half\ the\ duration\ of\ night^{(minutes)} - length\ of\ day^{(minutes)} = 1140m + 342m - 1440m = 42\ minutes$ .

### Example configuration

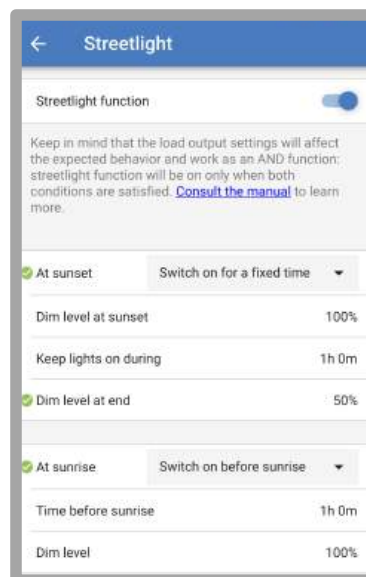

The selections which have been made on above screen image results in this program:

- At sunset - the light will be switched on for a fixed time.
- Dim level at sunset - at Full brightness (100%).
- Keep lights on during - the duration has been set to 1h 0m.
- Dim level at end - at the end of one hour the brilliance will be reduced to half (50%).

Also:

- At sunrise - the lighting will be adjusted before sunrise.
- Time before sunrise - at 1h 0m before sunrise, the following adjustment will be made:
- Dim level - full brilliance will be restored (100%).

#### 5.2.4. TX port settings

The VE.Direct-TX port can be used to send a signal to an external device. For example, to send a PWM signal to dim a streetlight.



Be aware that changing away from the default setting while a [jumper link \[16\]](#) is used, the jumper link will need to be removed and the load output algorithm has to be configured via the [VictronConnect load output setting \[22\]](#) instead.

To use the TX port, a [VE.Direct TX digital output cable](#) is needed.

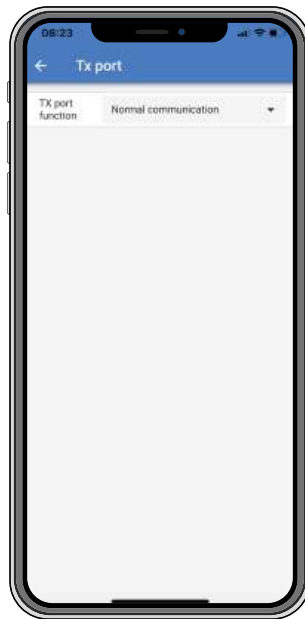

The functionality of the TX port can be set at:

- **Normal communication:**

This is the default setting. Use this function when connecting to a GX device, a VE.Direct Bluetooth Smart dongle, or any other device that needs to communicate with the solar charger via the VE.Direct port.

- **Pulse every 0.01 kWh:**

Use this function in combination with an energy meter.

The TX port will emit a pulse each time an additional 0.01kWh of energy has been harvested. The TX port is normally high and will be driven low for approximately 250ms for every 0.01kWh harvested.

- **Light dimming (PWM normal):**

Use this function in combination with the "Streetlight" setting.

The TX port PWM\* signal will be at 100% duty cycle when full light intensity is required.

- **Light dimming (PWM inverted):**

Use this function in combination with the "Streetlight" setting.

The TX port PWM\* signal will be at 0% duty cycle when full light intensity is required.

- **Virtual load output:**

Use this function to create a virtual load output for loads that draw more current than the load output is rated for.

The TX port will switch using the same conditions as set in the load output settings.

Connect the VE.Direct TX digital output cable to a BatteryProtect module, a relay or directly to the remote on/off connector of the load\*\*.

\*) The PWM signal is 5V, 160Hz.

\*\*\*) The TX port is a logic 5V signal. It can drive a maximum of a 22kOhm impedance load, where the output voltage is dropped to 3.3V. Make sure that the connected load is within this specification.

Note that these functionalities (other than the first functionality) do not disable the ability of the unit to communicate. What happens is that the unit will automatically detect incoming data, and while data is being received, it will resume normal communication. Once the data reception has been completed, it will automatically return to its configured TX function.

For more in-depth "developer style" information on the VE.Direct port see the [Data communication with Victron Energy products](#) document.

### 5.2.5. RX port settings

The VE.Direct-RX port can be used to receive a signal from an external device. For example to switch the solar charger on (or off) from a signal sent by a battery management system (BMS).



Be aware that changing away from the default setting while a [jumper link \[16\]](#) is used, the jumper link will need to be removed and the load output algorithm has to be configured via the [VictronConnect load output setting \[22\]](#) instead.

To use the RX port for remote on/off control a [VE.Direct non inverting remote on/off cable](#) is needed.

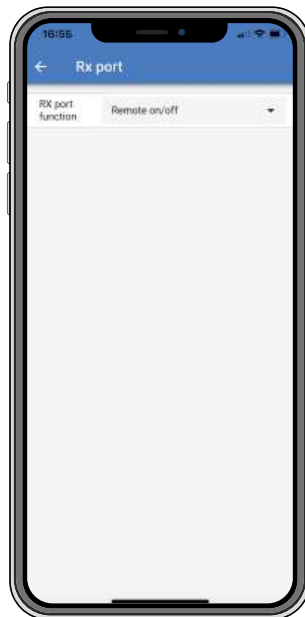

The functionality of the RX port can be set at:

- **Load output configuration:**

This is the default setting. The RX pin can be used to place a jumper to select the load output operation. See chapter [Load output settings \[22\]](#) for details.

- **Remote on/off:**

This functionality will switch the solar charger on or off via the RX pin.

- RX pin to GND will switch the solar charger off.
- RX pin floating or to battery positive will switch the solar charger on.

- **Load output on/off inverted:**

This setting reverses the load output on/off control:

- RX pin 0V will switch load output on.
- RX pin +5V will switch load output off.

- **Load output on/off normal:**

This setting allows load output on/off control:

- RX pin 0V will switch the load output off.
- RX pin +5V will switch load output on.

For more in depth "developer style" information on the VE.Direct port see the [Data communication with Victron Energy products](#) Whitepaper.





### 5.3. Updating firmware

The firmware can be checked and updated with the VictronConnect app.

The VictronConnect app might ask on the first connection to update the firmware. If this is the case, let it perform a firmware update.

If it did not automatically update, check if the firmware is already up to date using the following procedure:

- Connect to the solar charger.
- Click on the settings symbol .
- Click the options symbol .
- Go to product info.
- Check if you are running the latest firmware and look for the text: "This is the latest version".
- If the solar charger does not have the most up-to-date firmware, perform a firmware update.

### 5.4. VE.Smart Networking

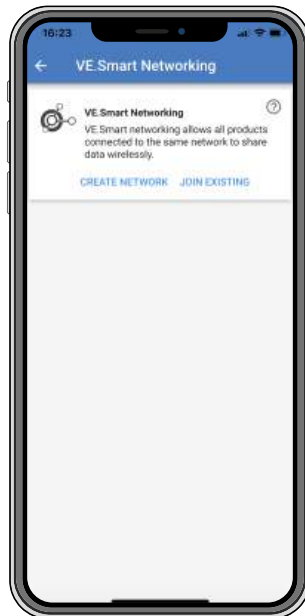

VE.Smart Networking allows a variety of products connected to the same network to share data via Bluetooth and is specially designed for smaller systems that do not have a GX device installed.

When this product is part of a VE.Smart Network, it can receive data or communicate with the following devices:

- All SmartSolar solar chargers.
- All BlueSolar solar chargers connected to a [VE.Direct Bluetooth Smart dongle](#).
- The [Smart Battery Sense](#).
- A [BMV or SmartShunt battery monitor](#) equipped with Bluetooth (or [VE.Direct Bluetooth Smart dongle](#)) and an optional [BMV temperature sensor](#).
- Certain Smart [AC chargers](#).
- The [SUN inverter](#).

For the product compatibility list see the [VE.Smart manual](#) located on the [VictronConnect app product page](#).

VE.Smart Networking can be used for:

- Temperature sensing - the measured battery temperature is used by the chargers in the network for temperature compensated charging and in case of lithium battery for the low temperature cut off.
- Battery voltage sensing - the measured battery voltage is used by the chargers in the network to to compensate the charge voltage should there be a voltage drop over the battery cables.

- Current sensing - The measured battery current is used by the charger so it knows the exact tail current at which the absorption stage should end and the float (or equalisation) stage should start. To measure the charge current all charge currents from all chargers are combined, or if a battery monitor is part of the network the actual battery current will be used.
- Synchronised charging - All chargers in the network will act as they were one large charger. One of the chargers in the network will assume a master role and the master will dictate the charge algorithm the other chargers will be using. All chargers will follow the same charge algorithm and charge stages. The master is selected randomly (not user settable) so it is important that all chargers use the same charge settings. During synchronised charging each charger will charge up to its own maximum charge current setting (it is not possible to set a maximum current for the whole network). For more information see the [VE.Smart manual](#) located on the [VictronConnect app product page](#).

This video introduces the Smart Battery Sense and some features of VE.Smart Networking:

<https://www.youtube.com/embed/v62wCfXaWXY>

### 5.4.1. VE.Smart Networking setup

#### VE.Smart Networking design notes:

There can only be one product in the network that transmits battery voltage and/or battery temperature. It is not possible to use a battery monitor together with a Smart Battery Sense, or multiple of these devices.

For the network to be operational all networked devices must be within Bluetooth transmission distance of each other.

A maximum of 10 devices can be joined into a VE.Smart Network.

Some older devices might not support VE.Smart Networking. for more information see the Limitations chapter in the [VE.Smart Networking manual](#).

#### Setting up the network

When setting up the network, first set up the Smart Battery Sense or battery monitor, and then add one or more solar chargers or AC chargers to the network.

All solar chargers and AC chargers need to have the same charge settings. The easiest way to do this is to use a preset battery type or a saved used defined battery type. A warning #66 message will be shown if there is a difference between the devices charge settings.

#### To set up a new network:

- Open the VictronConnect app.
- Select one of the devices that needs to become part of the new VE.Smart network.
- Navigate to the settings page by clicking the gear  symbol.
- click on "VE.Smart networking".
- Click on "create network".
- Enter a name for the new network.
- Click "save".
- Wait for confirmation that the network has been set up and click "OK".
- If more devices need to be added to this network go to next paragraph and join multiple devices to the network.

#### To join another device to an existing network:

- Open the VictronConnect app. Select a device that needs to become part of a VE.Direct network.
- Navigate to the settings page by clicking the gear  symbol.
- Click on "VE.Smart Networking".
- Click on "join existing".
- Select the network the device needs to be joined to.
- Wait for confirmation that the network has been set up and click "OK".
- Repeat above steps if more devices need to be added to the network.

#### To leave a network:

- Open the VictronConnect app.

- Select a device that needs to be removed from the VE.Direct network.
- Navigate to the settings page by clicking the gear  symbol.
- Click on "VE.Smart Networking".
- Click on "leave network".

**Check the network**

Once the network has been set up all devices communicate with each other. The active LED on each connected device will now blink every 4 seconds. This is an indication that the device is actively communicating with the network.

To check if an individual device is communicating with the network, click on the VE.Smart symbol  in the main screen next to the solar dail. A pop-up window will open showing the connection status and the shared parameters.



*VE.Smart Networking pop-up*

To check if all devices are actively communicating with the same VE.Smart Networking, navigate to the settings page of one of the networked devices and click on "VE.Smart Networking". A screen will be shown containing which device parameters of this device are shared and all the other devices that are connected to the same network are shown.

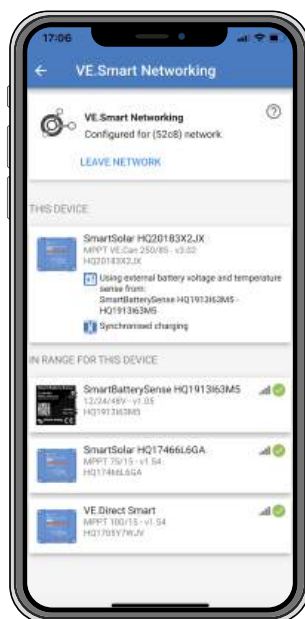

*Example of a VE.Smart Network*

**More information**

For more information see the [VE.Smart Networking manual](#).

## 6. Operation

### 6.1. Start up

The solar charger will power up as soon as it has been connected to a battery and/or to a solar panel. As soon as the solar charger has been powered up, it can communicate via the VE.Direct port. The solar charger's data can be read out and setting configurations can be made using the VictronConnect or the optional display.

The solar charger will commence battery charging as soon as the PV voltage is 5V higher than the battery voltage. For charging to continue, the PV voltage must remain at least 1V higher than the battery voltage.

### 6.2. Battery charging

The charge controller will start a new charge cycle every morning, when the sun starts shining and when the PV voltage is 5V higher than the battery voltage.

#### Default method to determine length and end of absorption for Lead-acid batteries

The charging algorithm behaviour of solar chargers differ from AC connected battery chargers. Please read this section of the manual carefully to understand the solar charging behaviour, and always follow the recommendations of your battery manufacturer.



The voltage values mentioned in this chapter are for 12V systems, for 24V systems multiply by 2 and for 48V systems multiply by 4.

By default, the absorption time is determined on idle battery voltage at the start of each day based on the following table:

Battery voltage at start up	Multiplier	Maximum absorption time
< 11.9V	x 1	6h
11.9V - 12.2V	x 0.66	4h
12.2V - 12.6V	x 0.33	2h
> 12.6V	x 0.16	1h

The default absorption voltage is 14.4V and the default float voltage is 13.8V.

The absorption time counter starts once switched from bulk to absorption.

The MPPT solar chargers will also end absorption and switch to float when the battery current drops below a low current threshold limit, the "tail current". The default tail current value is 1A.

The default settings (voltages, absorption time multiplier and tail current) can be modified with the VictronConnect app.

There are two exceptions to normal operation:

- When used in an ESS system; the solar charger algorithm is disabled; and instead it follows the curve as mandated by the inverter/charger.
- For CAN-bus Lithium batteries, like BYD, the battery tells the system, including the solar charger, what charge voltage to use. This Charge Voltage Limit (CVL) is for some batteries even dynamic; changes over time; based on for example maximum cell voltage in the pack and other parameters.

#### Variations to the expected charging behaviour

##### • Pausing of the absorption time counter:

The absorption time counter starts when the configured absorption voltage is reached and pauses when the output voltage is below the configured absorption voltage. An example of when this voltage drop could occur is when PV power (due to clouds, trees, buildings) is insufficient to charge the battery and to power the loads.

##### • Restarting the charge process:

The charging algorithm will reset if charging has stopped for an hour. This may occur when the PV voltage drops below the battery voltage due to bad weather, shade or similar.

##### • Battery being charged or discharged before solar charging begins:

The automatic absorption time is based on the start-up battery voltage (see table). This absorption time estimation can be incorrect if there is an additional charge source (eg alternator) or load on the batteries. This is an inherent issue in the default algorithm. However, in most cases it is still better than a fixed absorption time regardless of other charge sources or battery state. It is possible to override the default absorption time algorithm by setting a fixed absorption time when programming

the solar charge controller. Be aware this can result in overcharging your batteries. Please see your battery manufacturer for recommended settings.

- **Absorption time determined by tail current:**

In some applications it may be preferable to terminate absorption time based on tail current only. This can be achieved by increasing the default absorption time multiplier (warning: the tail current of lead-acid batteries does not decrease to zero when the batteries are fully charged, and this “remaining” tail current can increase substantially when the batteries age).

#### Default settings for LiFePO4 batteries

The default absorption voltage is to 14.2V (28.4V, 56.8V) and the absorption time is fixed and set to 2 hours. The float voltage is set at 13.5V (27V, 54V). Equalization is disabled. The tail current is set to 0A, this so that the full absorption time is available for cell balancing. The temperature compensation is disabled and the low temperature cut off is set to 5. These settings are the recommended settings for LiFePO4 batteries, but they can be adjusted if the battery manufacturer specifications advise otherwise.

#### Reset of the charge algorithm:

The default setting for restarting the charge cycle is  $V_{bat} < (V_{float} - 0.4 V)$  for lead-acid, and  $V_{bat} (V_{float} - 0.1 V)$  for LiFePO4 batteries, during 1 minute. These values are for 12 V batteries, multiply by two for 24V and by four for 48V.

## 6.3. Automatic equalization



Do not equalize charge Gel, AGM, VRLA or lithium batteries.

Equalization can cause damage to the battery if the battery is not suitable for an equalization charge. Always check with the battery manufacturer prior to enabling equalization.

Automatic equalization is by default disabled. When enabled, it can be configured with a number between 1 (every day) and 250 (once every 250 days).

When automatic equalization is active, the absorption charge will be followed by a voltage limited constant current period. The current is by default limited to 8% of the bulk current and can be adjusted between 0% and 100%. The bulk current is set by default to the maximum charge current the solar charger is capable of, unless a lower charge current has been chosen.

The maximum equalization duration is set by default to 1 hour and can be configured between 0 minutes and 24 hours. The automatic equalization will end when the voltage limit has been reached or when the set maximum equalization duration has been reached, whichever comes first.

When automatic equalization has not finished within a day, it will not resume the next day. The next equalization session will take place as determined by the day interval.

## 6.4. Lithium batteries

Lithium Iron Phosphate (LiFePo4) batteries do not need to be fully charged to prevent premature failure. The default lithium (and recommended) settings are:

Setting	Absorption voltage	Absorption time	Float voltage
12V system	14.2V	2h	13.2V
24V system	28.4V	2h	26.4V
48V system	56.8V	2h	52.8V

These settings are adjustable.

## 6.5. Shutdown and restart procedure

The solar charger is always active when the PV and/or the battery terminals are powered. The solar charger does not have an on/off switch.

#### To shut down the solar charger, perform these steps in the prescribed order:

1. Disconnect the PV supply to the solar charger by switching the PV supply off or by removing the external fuse(s) or circuit breaker(s).
2. Disconnect the battery supply to the solar charger by switching the battery supply off or by removing the external fuse(s) or circuit breaker(s).

#### To restart the solar charger after it was shutdown, perform these steps in the prescribed order:

1. Connect the battery supply to the solar charger by switching the battery supply on or by inserting the external fuse(s) or circuit breaker(s).

2. Reconnect the PV supply to the solar charger by switching the PV supply on or by inserting the external fuse(s) or circuit breakers(s).

## **6.6. Maintenance procedure**

The solar charger does not need regular maintenance.



## 7. Monitoring

This chapter describes all various monitoring methods and for each method how to access live data, historic data and errors.



















### 7.1. LED indications

The solar charger has three LEDs to indicate operational status, a blue, green and a yellow LED. These LEDs respectively indicate the charge stages bulk, absorption and float, but are also used to indicate other charge situations and fault situations.















Errors are indicated via a combination of LEDs that are on, off, or are blinking. Each LED combination has a meaning, indicating either a normal operation mode, or indicating an error.

Symbol	Meaning
	Permanent on
	Blinking
	Off

Overview of LED indications:

Operation mode	Bulk LED	Absorption LED	Float LED
Not charging <sup>1</sup>			
Bulk <sup>1</sup>			
Absorption <sup>2</sup>			
Manual equalisation (alternating blinking) <sup>2</sup>			
Automatic equalisation <sup>2</sup>			
Float <sup>2</sup>			

1. The bulk LED will blink briefly every 3 seconds when the system is powered but there is insufficient power to start charging.
2. The LED(s) might blink every 4 seconds indicating that the charger is receiving data from another device, this can be a GX device (ESS) or a VE.Smart Network link via Bluetooth

Fault mode	Bulk LED	Absorption LED	Float LED
Charger temperature too high			
Charger over-current			
Charger or panel over-voltage			
VE.Smart networking or BMS issue			
Internal error, calibration issue, settings data lost or current sensor issue.			

For the latest and most up-to-date information about the LED blink codes, refer to the Victron Toolkit app. The app is available for Apple and Android. The app can be downloaded from the respective app stores or alternatively follow the download links on our [software downloads page](#).



## 7.2. Error codes

In case of an error, an error code will be displayed in the following ways:

- Via its LEDs.
- Via the VictronConnect app while it is connected to the solar charger.
- Via an optional MPPT control or SmartSolar Control display.
- Via an optional GX device or GlobalLink 520 and the VRM Portal.

For the meaning of blinking LED codes, see the previous chapter or the [Victron Toolkit app](#).

For a full list of error codes and their meaning see the [Error code overview](#) chapter.

## 7.3. Monitoring via the VictronConnect app

The VictronConnect app can be used to monitor the solar charger, see its historical values and if there are operational warnings or errors.

This chapter explains the solar charger-specific VictronConnect app usage. Refer to the general [VictronConnect app manual](#) for information about the VictronConnect app itself, such as: how to install the app, how to connect to the solar charger, how to update firmware and more.



Where battery voltage is referred in this chapter, a 12V battery is assumed.

To arrive at values for 24V, 36V or 48V batteries, multiply the 12V values by a factor of 2, 3 or 4 respectively.

### 7.3.1. VictronConnect app status screen

The status screen displays the solar charger model name together with the live solar charger information.



#### VE Smart Networking

- The presence of the VE.Smart Networking symbol  indicates that the solar charger is configured for VE.Smart Networking and is receiving battery temperature and/or battery voltage data from the VE.Smart Network.

#### Solar

- The solar gauge shows the solar output in relation to the maximum output power that the solar charger can generate at the set battery voltage and displays the dynamic real-time value of the solar array output power.
- The solar voltage measured at the solar terminals of the solar charger.
- The solar current flowing from the PV array into the solar charger.

#### Battery

- The battery voltage measured at the battery terminals of the solar charger.
- The current flowing from the solar charger in or out of the battery. A positive notation indicates that current is flowing into the battery and a negative notation indicates that current is being drawn from the battery.
- The battery state indicates the battery charge stage or if external control is active. These are the possible states:

Bulk

During this stage the solar charger delivers as much charge current as possible to rapidly charge the batteries. When the battery voltage reaches the absorption voltage setting, the solar charger activates the absorption stage.

Absorption

During this stage the solar charger switches to the constant voltage mode, where a pre-set absorption voltage is applied. When the charge current decreases below 1A or if the pre-set absorption time has elapsed, the battery is fully charged and the solar charger will enter the Float stage. Note that when an automatic equalisation is being performed this will also be reported as absorption.

Float

During this stage the float voltage is applied to the battery to maintain a fully-charged state. When the battery voltage drops below float voltage during at least 1 minute, a new charge cycle will be triggered.

External control

This will be displayed when another device is controlling the charge behaviour of the solar charger, bypassing its normal charge algorithm. Examples are when the solar charger is controlled by an ESS system or a managed battery.

- In case the charger is not charging a "Why is the charger off?" message will display. When clicking on this message, a new window will open with more information as to why the solar charger is not charging.

**Load output**

- The state of the load output, being switched on or switched off.
- The current drawn by the loads like electronic devices, lights, fridge and so on.
- The power drawn by the loads.





Note that for the load output readings to be reliable, all loads must be wired directly to the load output, including their negative terminals. If this is not the case consider adding a [battery monitor](#) which will measure all current going to or being drawn from the battery, including loads connected directly to the battery and not just the load output terminals of the solar charger.

**7.3.2. VictronConnect app history screen**

The history screen shows a summary of the data collected over the previous 30 days. Swipe the screen to the right or left to show any of the 30 days.



To switch between portrait or landscape screen presentation click the fragmented square icon,  or , at the top left of the screen.



The daily log shows:

- **Solar yield:** The energy (Wh) converted for that day.
- **Solar Pmax:** The maximum power (W) recorded during the day.
- **Solar Vmax:** The highest voltage (V) from the PV array during the day.
- **Battery max and min:** The first figure shows the maximum battery voltage (Vmax) for the day. The figure below is the minimum battery voltage (Vmin) for the day.
- **Errors:** This shows the daily number of errors, if any. To get more information about the error(s), click the orange dot. You may need to slide the display on your device up to see the errors.)
- **Lifetime total:** This shows the total energy converted by the installation (W and is not re-settable).
- **Since reset:** This shows how much energy has been converted by the installation since the last reset.

Clicking on any bar (day) in the graph will expand the information. It will show the time and percentage of the total charge time that the solar charger has spent in each Bulk, Absorption and Float charge stage.



You can use the charge times to see if the PV array is properly sized for your requirements. A system that never reaches the float stage may need more panels. Or perhaps the load should be reduced?

The history can be exported as a comma-separated file (CSV) by clicking the three connected dots symbol  or the save symbol  at the top right of the history screen. The symbol varies, depending on what platform VictronConnect is used.

The history can be reset by clicking the clock with an arrow symbol  at the top right of the history screen.

### 7.3.3. VictronConnect app error reporting

The VictronConnect app will indicate active errors while the app is actively connected to the solar charger. The error will show up in a pop-up window on the status screen together with the error number, name and a short error description.

The VictronConnect app also displays historical errors. To see these errors, navigate to the “History” tab and look at the bottom of each day column. An orange dot will indicate an error on that day.



An active error and a historical error.

## 7.4. Monitoring via a GX device and VRM

If the solar charger is connected to a [GX device](#), all its data can be accessed via the GX device. The GX device will also notify in case of solar charger alarms or faults.

For more information see the GX device manual.

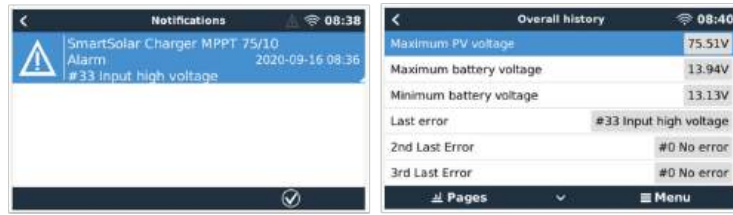

GX device showing alarm notification and historic errors.

If the GX device is connected to [Victron Remote Monitoring \(VRM\) portal](#), the solar charger can be monitored remotely via the internet.

All solar charger data, alarms and errors can be accessed via the VRM portal and solar charger settings can be remotely changed via the VRM portal with the VictronConnect app.

Alarm logs for Margreet test bench CCGX 2				
Device	Triggered by	Description	Started at	Cleared after
Solar Charger (256)	Automatic monitoring	Error code: #33 - Input voltage too high	2020-09-16 08:35:18	6s

Solar charger alarm logging via VRM

## 8. Troubleshooting

Refer to this chapter for addressing any unforeseen behaviour of the solar charger. Start by reviewing the common issues listed here during troubleshooting.

If the problem persists or requires technical assistance, contact the point of purchase – the Victron Energy dealer or distributor. If unsure whom to reach or unaware of the point of purchase, visit the [Victron Energy Support](#) webpage for guidance.

### 8.1. Solar charger is damaged

Before proceeding with troubleshooting, it is important to inspect the solar charger for any visible damage. Please note that damage to the solar charger is typically not covered by warranty.

By conducting this initial visual inspection, you can identify any visible damage that may impact the functionality of the solar charger:

Visual inspection	
<b>Step 1</b>	Examine the solar charger for any signs of mechanical damage to the housing or electrical terminals. Please be aware that this type of damage is not covered by warranty.
<b>Step 2</b>	Inspect the electrical terminals of the solar charger for signs of burning or melting. This type of damage is often caused by loose electrical connections, the use of rigid core cables, or exceeding the MC4 terminal current ratings. Please be aware that this damage is not covered by warranty. Refer to chapter <a href="#">PV connections burned or melted [54]</a> for more information.
<b>Step 3</b>	Look for any indications of water damage or corrosion on the solar charger, especially around the electrical connection area. It is important to note that such damage is not covered by warranty.
<b>Step 4</b>	<u>For the 75/15 model only:</u> This model uses sand for internal heat dissipation. If the solar charger experiences severe mechanical damage, like being dropped from a height onto a concrete floor, the sand may leak from the housing. Consider this when evaluating the solar charger.

### 8.2. Solar charger is unresponsive

If the solar charger is unresponsive, it means that none of its LEDs will illuminate or blink, there is no charging activity, and it is unable to establish communication with the VictronConnect app through the VE.Direct port.

Conversely, if the solar charger is active, you will notice its LEDs are either illuminated or blinking, and it can successfully communicate with the VictronConnect app via the VE.Direct port.

The solar charger should activate as soon it receives power from the battery, the PV supply, or both. Note that the solar charger does not have an on/off switch.

To troubleshoot, verify that the solar charger is receiving either battery or PV power, using the below procedure.

Unresponsive solar charger troubleshooting procedure	
<b>Step 1</b>	Set a multimeter to DC voltage mode.
<b>Step 2</b>	<ul style="list-style-type: none"> <li>Measure the voltage between the positive and negative battery terminals of the solar charger.</li> <li>Measure the voltage between the positive and negative PV terminals of the solar charger.</li> </ul>  <div style="border: 1px solid black; padding: 5px; margin-top: 10px;"> <p><b>⚠ WARNING:</b> Certain solar charger models may have PV voltages up to 250Vdc. Voltages exceeding 50V are generally considered dangerous. Only a qualified technician should handle dangerous voltages.</p> </div>

Unresponsive solar charger troubleshooting procedure	
<b>Step 3</b>	<p>If the battery or PV voltage is below the minimum voltage, check the following:</p> <ul style="list-style-type: none"> <li>• Check the continuity of the battery and PV supply cables.</li> <li>• Inspect the fuses and circuit breakers in the battery and PV supply cables.</li> <li>• Ensure that all cable connections are sufficiently tightened.</li> <li>• Verify if the battery voltage is sufficiently high. If not, charge the battery using an auxiliary charger.</li> <li>• Confirm if the PV voltage is sufficiently high. Check for any issues with the PV array, such as wiring mistakes, damaged panels, cloudy weather, nighttime conditions, etc.</li> </ul>
<b>Step 4</b>	<p>If, even after confirming sufficient battery or PV voltage, the solar charger remains unresponsive, consider the solar charger to be faulty.</p>

### 8.3. Solar charger is off

When the solar charger is off, the VictronConnect app shows this on the status screen. Click the "Why is the charger off?" text for a pop-up window with an explanation and possible remedies.

#### The reasons why the solar charger is off:

- There is insufficient PV power. Refer to the [PV voltage too low \[42\]](#) subchapter.
- The settings are being edited on an external display. Refer to the [Settings being edited on an external display \[43\]](#) subchapter.
- The charger is disabled in the settings. Refer to the [Disabled in the settings \[44\]](#) subchapter.
- The charger is disabled by remote or BMS. Refer to the [Disabled by remote or BMS \[44\]](#) subchapter.
- Low lithium battery temperature. Refer to the [Low lithium battery temperature \[44\]](#) subchapter.

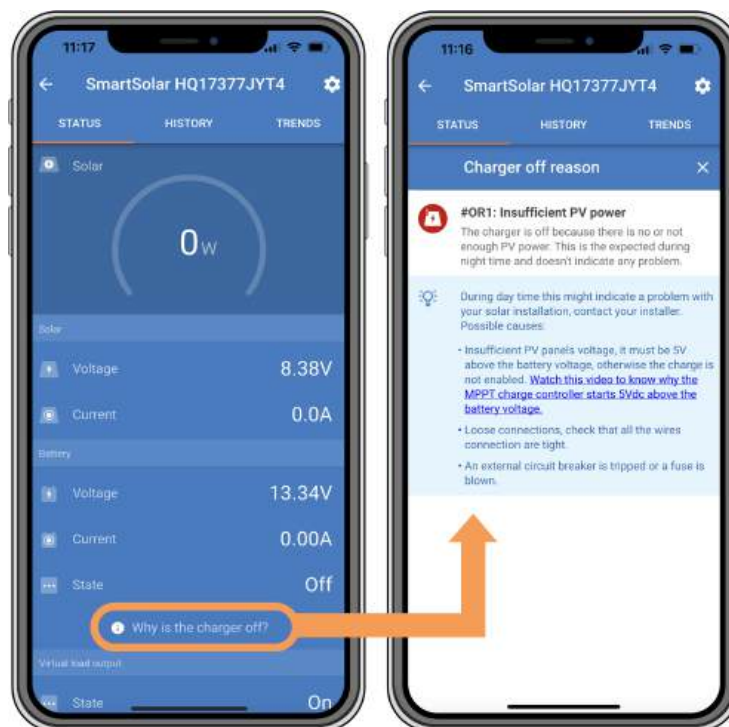



VictronConnect app – Why is the charger off?

#### 8.3.1. PV voltage too low

The solar charger starts charging when the PV voltage is 5V above the battery voltage. Charging continues if the PV voltage remains 1V higher than the battery voltage.

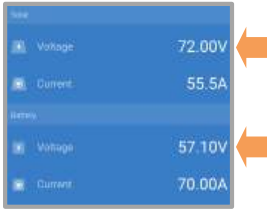
To troubleshoot if a low PV voltage is the reason the solar charger is not charging, use the below procedure.

PV and battery voltage check	
<b>Step 1</b>	<p>Use the VictronConnect app, a solar charger display or a GX device to check the battery and PV voltage.</p> 
<b>Step 2</b>	<p>If the above step is impossible, use a multimeter in DC mode to measure the battery and PV voltages at the solar charger terminals.</p>  <div style="border: 1px solid black; padding: 5px; margin-top: 10px;"> <p><b>⚠ WARNING:</b> Certain solar charger models may have PV voltages up to 250Vdc. Voltages exceeding 50V are generally considered dangerous. Only a qualified technician should handle dangerous voltages.</p> </div>
<b>Step 3</b>	<p>Compare both voltages. Remember that the PV voltage needs to be 5V higher than the battery voltage for charging to commence.</p>

#### Possible reasons why the solar voltage might be too low:

- Insufficient solar irradiance is reaching the solar panels:
  - It is night.
  - There is cloudy or bad weather.
  - There is shade from nearby objects. See this [shading blog story](#) for more information.
  - The panels are dirty.
  - There are seasonal differences. The sun angle is lower in winter.
  - The panels have an incorrect panel orientation or inclination.
- There are issues with a solar panel or the solar panel wiring:
  - There is a mechanical or electrical issue with an individual panel (or multiple panels).
  - Wiring problems, like loose wires, loose connections or incorrect crimped MC4 connectors.
  - Blown fuses.
  - Open or faulty circuit breakers.
  - Issues with splitters, combiners or incorrect usage of these components.
- Incorrect PV array design or configuration:
  - The PV array is misconfigured. For example, there are an insufficient number of panels in a series string.
- Reverse PV polarity:
  - The positive and negative PV wires have been mistakenly swapped when connected to the solar charger. For more information, see the [Reverse battery polarity \[46\]](#) chapter.

#### 8.3.2. Settings being edited on an external display

Charging is disabled when a [MPPT Control](#) external display is used to make configuration changes.

Once the settings menu is closed on the display, charging will resume.

### 8.3.3. Disabled in the settings

The charger has been disabled in the settings.

Check the VictronConnect app battery settings page to ensure that the charger has been enabled.



*VictronConnect app charger enable/disable setting*

### 8.3.4. Disabled by remote or BMS

The charger has been switched off via its VE.Direct port.

Note that in systems with lithium batteries together with an external BMS, it is typical for the solar charger to be switched on or off as needed. This happens when the BMS turns off the charger due to full batteries or low temperatures (below  $\sim 5^{\circ}\text{C}$ ). Charging automatically resumes when the batteries are discharged or have warmed up.

If the solar charger has unexpectedly been switched off, check the following:

VE.Direct RX port functionality check	
The VE.Direct port can be used to switch the solar charger on or off by utilising its RX functionality in combination with, for example, a <a href="#">VE.Direct non-inverting remote on/off cable</a> .	
<b>Step 1</b>	check if the RX port has been configured correctly. For more information, see the <a href="#">RX port settings [28]</a> chapter and the <a href="#">VE.direct protocol</a> documentation.
<b>Step 2</b>	If a <a href="#">VE.Direct non-inverting remote on/off cable</a> ) is used, check if it is in good working order.
<b>Step 3</b>	If a non-Victron cable is used, check if it is configured correctly. For more information see the <a href="#">VE.direct protocol</a> documentation.

### 8.3.5. Low lithium battery temperature

Charging may be suspended if the battery temperature is low, as a part of the battery protection mechanism, without necessarily indicating a problem. The rationale behind this precaution is that lithium batteries are prone to damage when charged in temperatures below  $^{\circ}\text{C}$ .

If this protection is triggered unnecessarily, please reach out to your installer to adjust the related settings.

## 8.4. Solar charger is externally controlled

Managed batteries or an inverter/charger with an external control system (e.g., ESS system) can govern the solar charger via a GX device. The external system determines charging permissions and sets the charge voltage and currents.

When external control is active, it is visible on both the VictronConnect app and the GX device. This is normal behaviour and is not a fault.



*The VictronConnect app indicates that the charger is externally controlled.*

## 8.5. Batteries are not charged

This chapter explains scenarios where the charger is active, but the batteries are not charging. In such cases, the VictronConnect app will show the charger as active with the correct charge voltage, but the charge current will be at zero or very close to zero.

**There are several reasons why this can happen, namely:**

- The battery is fully charged, and no further current is required. This is normal behaviour and is not a fault. Refer to the [Battery is full \[45\]](#) chapter for more details.
- Reverse PV polarity. Refer to the [Reverse PV polarity \[48\]](#) subchapter for more details.
- PV voltage is too high. Refer to the [PV voltage too high \[48\]](#) subchapter for more details.



- Reverse battery polarity. Refer to the [Reverse battery polarity \[46\]](#) subchapter for more details.
- The solar charger is disconnected from the battery, possibly due to cable, fuse, or circuit breaker issues. Refer to the [Battery not connected \[45\]](#) subchapter for more details.
- Incorrect charger configuration, e.g., low charge voltage or current setting. Refer to the [Battery settings too low \[47\]](#) subchapter for more details.
- The charger is externally controlled (ESS or DVCC), which is normal and not a fault. Refer to the [Solar charger externally controlled](#) chapter for more details.
- The temperature-compensated charging feature is active, and the battery temperature is too high, or the feature is misconfigured. Refer to the [Wrong temperature compensation setting](#) chapter for more details.



The VictronConnect app shows a close to zero charge current.

### 8.5.1. Battery is full

Once the battery is full, the solar charger will stop or significantly reduce its charge current. This is especially evident when DC loads are not drawing power from the battery. It is important to note that this behaviour is normal and not a fault.

To determine the battery's state of charge (SoC), check the battery monitor (if available) or inspect the charge stage indicated by the solar charger. During the daily charge cycle, the solar cycle progresses through the following stages:

1. Bulk stage: 0-80% SoC.
2. Absorption stage 80-100% SoC.
3. Float stage: 100% SoC.

Be aware that the solar charger may detect the battery as fully charged when it's not. This happens if the charge voltages are set too low, causing the charger to switch from absorption to float stage prematurely. Refer to the [Battery settings too low](#) chapter.

### 8.5.2. Battery not connected



To ensure proper battery charging, a correct connection to the battery is crucial.

Be aware that that if the solar charger operates without a battery, it may seem connected, showing battery voltage and charge stage in the VictronConnect app, but the charge current will be negligible or zero.

#### Potential reasons for a disconnected battery:

- Loose or missing battery cables.
- Loose cable connections.
- Poorly crimped cable terminals.
- A blown (or missing) fuse in the battery supply cable.

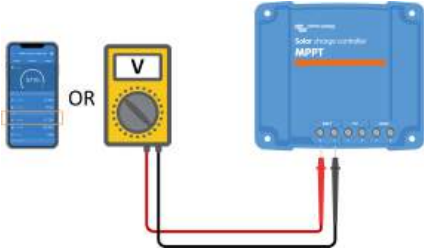
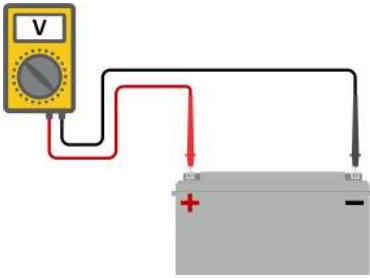
- Open (or faulty) circuit breaker in the battery supply cable.
- Incorrectly wired battery cables.

Battery voltage check	
<b>Step 1</b>	<p>Use the VictronConnect app, a connected display or a GX device to read the solar charger battery voltage. Alternatively, use a multimeter to measure the battery voltage at the terminals of the solar charger.</p> 
<b>Step 2</b>	<p>Use a multimeter to measure the voltage at the battery terminals.</p> 
<b>Step 3</b>	<p>Compare the two voltages.</p>
<b>Step 4</b>	<p>In case of a voltage difference, investigate the reason behind it by tracing the path from the solar charger to the battery to identify the cause.</p> <ul style="list-style-type: none"> <li>• Check and confirm that all cabling is accurately connected and that there are no wiring errors.</li> <li>• Inspect the cable connections for tightness while keeping the maximum torque levels in mind.</li> <li>• Verify the correct crimping of all cable lugs or terminals.</li> <li>• Check the fuses and circuit breakers.</li> </ul> <div style="border: 1px solid #0070C0; padding: 5px; margin-top: 10px;">  <p>Should you come across a blown fuse, make sure to check the correct wiring of the battery polarity before replacing it. Refer to the <a href="#">Reverse battery polarity [46]</a> chapter.</p> </div>

### 8.5.3. Reverse battery polarity

Reverse polarity occurs when the positive and negative battery cables are accidentally swapped. This means the negative battery terminal connects to the positive solar charger terminal, and the positive battery terminal connects to the negative solar charger terminal.

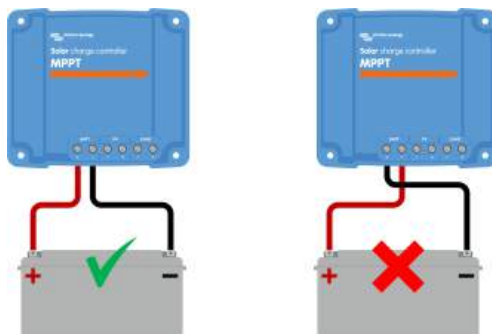

Examples of correct and incorrect (reverse) battery polarity.



Be aware that a red or positively labelled cable may not necessarily indicate the cable is positive. A wiring or labelling mistake during the solar charger installation is possible.

Always double-check the battery polarity before reconnecting the battery wires to the solar charger.

Reverse battery polarity has the potential to damage the solar charger, causing its fuse to blow for fail-safe protection. This fuse might blow before the external fuse in the battery cable. If you encounter a blown solar charger fuse, before attempting replacement, refer to the [Blown fuse](#) chapter to assess if replacing the fuse will fix the solar charger. In some cases, the solar charger may still be considered faulty even after a fuse replacement.

The solar charger is not protected against reverse battery polarity, and any resulting damage is not covered under warranty.

#### 8.5.4. Blown fuse

The solar charger is equipped with an accessible fuse, which typically blows when the battery is mistakenly connected in reverse polarity.

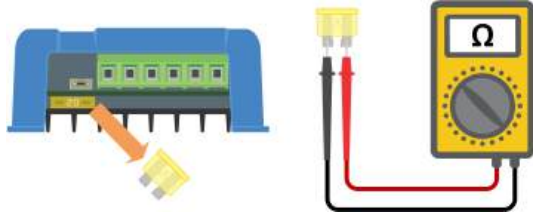
Steps to check the fuse:	
<b>Step 1</b>	Remove the fuse.
<b>Step 2</b>	Use a multimeter in resistance mode to check for continuity. 
<b>Step 3</b>	If the fuse is faulty, verify the battery polarity and correct it if necessary. Refer to the <a href="#">Reverse PV polarity [48]</a> chapter. Keep in mind that reverse battery polarity is not covered by warranty.
<b>Step 4</b>	If the new fuse also blows, the unit may be considered faulty.

#### 8.5.5. Battery settings too low

If the solar charger's charge voltage and current are well below the manufacturer's recommended levels, the battery charging process may become inadequate or excessively slow. Incorrect configuration can be a contributing factor, including:

- Setting the "Battery voltage" parameter too low.
- Setting the "Absorption voltage" and "Float voltage" parameters too low.
- Setting the "Max charge current" parameter to zero or an excessively low value.

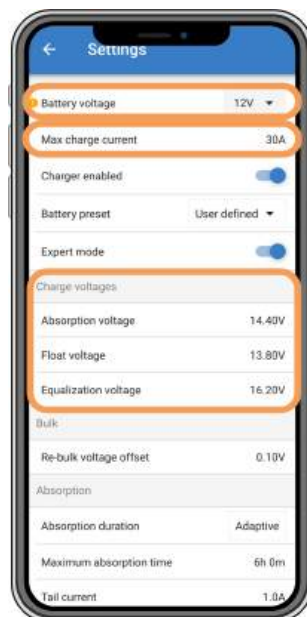

*VictronConnect app, showing battery (system) voltage, charge current and charge voltages settings.*

### 8.5.6. PV voltage too high

The PV voltage should always stay within the maximum rated limit of the solar charger, as indicated in its product name, type plate and [Technical specifications](#) [62]. The solar charger can sustain damage based on the extent of the PV voltage height, and it's important to note that such damage is not covered by warranty.

Should the PV voltage exceed the maximum rated PV voltage, the solar charger will cease charging, showing an overvoltage error #33 with rapid blinking of the absorption and float LEDs. Charging resumes only when the PV voltage drops 5V below the rated maximum voltage.

During investigations into high voltage issues, it's essential to review the VictronConnect app, solar charger display, or GX device history. Check for the highest PV voltage recorded each day ( $V_{max}$ ) and past overvoltage warnings.

To avoid issues, check the open circuit voltage ( $V_{oc}$ ) rating of the PV array and ensure it is lower than the solar charger's maximum rated voltage. Use the MPPT sizing calculator on the [solar charger product page](#). For PV arrays in cold climates or with night temperatures nearing or below 10°C, it's essential to consider possible increased output (more than its rated  $V_{oc}$ ). As a rule of thumb, maintain an additional 10% safety margin.



*VictronConnect app error #33 indication on the status screen and history screen.*

### 8.5.7. Reverse PV polarity

When the solar charger is installed within the published specifications, internal protection guards the PV input against reverse PV polarity, and no error is displayed in such cases.

**To identify reverse PV voltage, watch for these indicators:**

- Absence of battery charging with the charge current remaining at zero.
- Excessive heat generated by the solar charger.
- PV voltage reading zero or close to zero.

To verify, use a multimeter to ensure that the positive PV cable is correctly connected to the positive PV terminal and the negative cable is connected to the negative PV terminal.

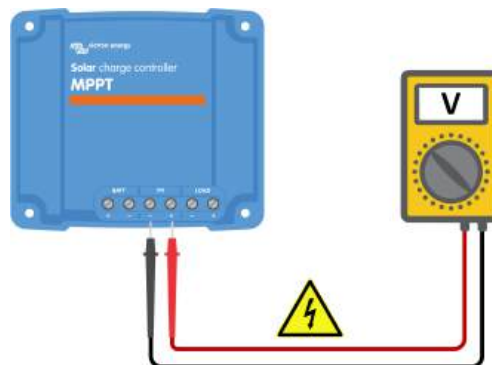

**WARNING:** Certain solar charger models may have PV voltages up to 250Vdc. Voltages exceeding 50V are generally considered dangerous. Only a qualified technician should handle dangerous voltages.

## 8.6. Batteries are undercharged

This chapter addresses the issue of undercharged batteries. It explores possible reasons why the solar charger might not be adequately charging the batteries and provides steps to check or resolve the situation.

### Some signs of undercharged batteries include:

- Batteries taking too long to charge.
- Batteries not being fully charged by the end of the day.
- Charge current is less than expected.

### Several factors can cause this, such as:

- Insufficient solar supply. Refer to the [Insufficient solar supply \[49\]](#) subchapter.
- High DC load. Refer to the [DC load too high \[49\]](#) subchapter.
- Voltage drop in battery cables. Refer to the [Battery cable voltage drop \[50\]](#) subchapter.
- Incorrect temperature compensation setting. Refer to the [Temperature compensation setting incorrect \[51\]](#) subchapter.
- Temperature difference between the solar charger and battery. Refer to the [Temperature difference between solar charger and battery \[51\]](#) subchapter.
- Battery charge voltages or current settings are too low. Refer to the [Battery settings too low \[47\]](#) chapter.

### 8.6.1. Insufficient solar supply

Check if the solar charger reaches the float charge stage each day.

To investigate, check if the solar charger reaches the float charge stage each day. Utilise the VictronConnect app's history tab, where a histogram displays the daily charging durations in the Bulk, Absorption, and Float stages for the last 30 days. Clicking on a histogram column provides a breakdown of the charge stages.

You can use the charge times to assess whether the PV array is appropriately sized for your needs.

#### Reasons for the solar charger not reaching the float stage include:

- An inadequate number of solar panels.
- Excessive DC load.
- PV array issues causing reduced power output.
- Solar charger is unable to reach full output. Refer to the [Solar charger not achieving full output \[52\]](#) chapter.

Please note that this information does not apply to an ESS system. An ESS system will continuously be in the bulk charge stage while connected to the grid.



Left: Example of a system that is spending all its time in the bulk stage. Right: Breakdown of the charge stages - The system spends time in bulk and in the absorption stage.

### 8.6.2. DC load too high

The solar charger not only charges the batteries but also supplies power for the system's DC loads, such as lights, refrigerators, inverters, inverter/chargers and more.

Battery charging occurs only when the power generated by the PV panels exceeds the power consumed by the system's DC loads.

To check the PV array's power generation and load power usage:

#### To check the PV array's power generation and load power usage:

- Connect all DC loads to the output and check how much power the PV array is generating and how much power the loads use.

- If the system includes a properly installed and configured battery monitor, you can monitor the current flowing in (or out) of the battery, while the solar charger indicates the current generated by the solar array.
- Use a current clamp and compare the current flowing from the solar charger into the battery and the current flowing from the battery into the DC system.
- A positive sign alongside the current reading indicates current flowing into the battery, whereas a negative sign suggests current being drawn from the battery.

### 8.6.3. Battery cable voltage drop

If the battery cables experience a voltage drop, the solar charger will produce the correct voltage, but the batteries will receive a lower voltage, potentially leading to undercharged batteries. An excessive voltage drop of more than 2.5% is unacceptable.

#### The voltage drop can result in the following:

- Longer battery charging times.
- Battery receiving a charge voltage that is too low.
- Loss of charge power.
- Increased heat in the battery cables.

#### The voltage drop can be caused by:

- Battery cables with insufficient cross-sectional area.
- Poorly crimped cable lugs or terminals.
- Loose terminal connections.
- Faulty or loose fuse(s).

For more information on cabling issues and voltage drop, refer to the [Wiring Unlimited Book](#).

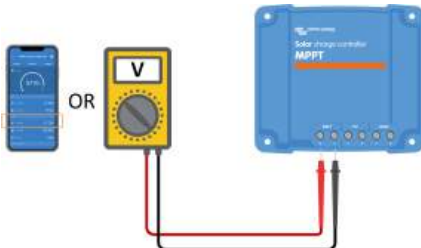
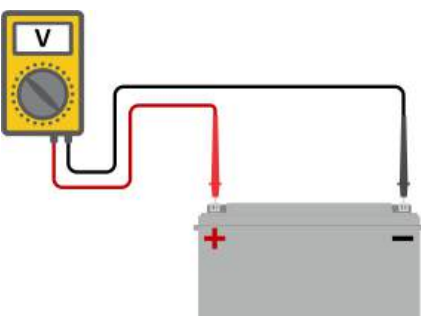
Battery cable voltage drop check	
<b>Step 1</b>	Make sure that the charger is charging with the full current, preferably in the morning. Use the VictronConnect app to confirm the output current.
<b>Step 2</b>	Using the VictronConnect app or a multimeter, measure the voltage on the battery terminals of the solar charger. <div style="text-align: center;">  </div>
<b>Step 3</b>	Measure the battery voltage on the terminals of the battery using a multimeter. <div style="text-align: center;">  </div>
<b>Step 4</b>	Compare the two voltages to identify any voltage difference.

VE.Smart Networking can assist in mitigating a small cable voltage drop. However, for a substantial voltage drop, there may be an issue with the wiring between the solar charger and the battery, which requires rectification before proceeding.

In a VE.Smart Network a [Smart Battery Sense](#) or battery monitor measures the battery terminal voltage and transmits this via VE.Smart Networking to the solar charger. If the battery voltage is less than the solar charge voltage, the solar charger will increase its charge voltage to compensate for (small) voltage losses.

#### 8.6.4. Temperature compensation setting incorrect

Improperly configuring the temperature compensation coefficient can lead to either undercharged or overcharged batteries.

Note that temperature compensation is typically applicable only to lead-acid batteries.

To determine the correct temperature compensation coefficient for your battery, consult the battery documentation. If uncertain, use the default value of  $-64.80\text{mV}/^{\circ}\text{C}$  for lead-acid batteries, and for lithium batteries, disable the temperature compensation setting.

#### 8.6.5. Temperature difference between solar charger and battery

For proper operation, it is crucial that the ambient temperatures of both the battery and the solar charger are equal, especially if the solar charger is not receiving battery temperature data.



Note that this chapter does not apply if the solar charger is connected to a VE.Smart Network with a battery temperature measurement or is equipped with a temperature sensor.

At the beginning of the day, as soon as power is generated by the solar array, the solar charger will measure the ambient temperature and use it to temperature-compensate the charge voltage.

During the float stage, the solar charger will re-measure the ambient temperature and adjust the voltages accordingly.

Large differences in ambient temperature between the solar charger and the battery can lead to improper charging voltages for the battery.

For instance, if the solar charger is placed near a sunlit window while the batteries are located on a cold concrete floor in the shade, this temperature discrepancy can affect the charging process.

To ensure optimal performance, always ensure that the ambient conditions are equal for both the solar charger and the battery.

### 8.7. Batteries are overcharged



**WARNING:** Overcharging batteries can be extremely dangerous! There is a significant risk of battery explosion, fire, or acid leakage. To prevent accidents, do not smoke, create sparks, or have open flames in the same room where the batteries are located.



Overcharging batteries can lead to severe battery damage and may be caused by the following factors:

- Incorrect charge voltage settings. Refer to the [Battery charge voltage settings too high \[52\]](#) subchapter.
- Battery voltage setting too high. Refer to the [Battery voltage setting too high \[51\]](#) subchapter.
- Applying equalisation while the battery is not suitable for it. Refer to the [Battery unable to deal with equalisation \[52\]](#) subchapter.
- The battery is too small, old, has been mistreated in the past or is faulty. Refer to the [Battery old, faulty or undersized \[52\]](#) subchapter.

#### 8.7.1. Battery voltage setting too high

If the "battery voltage" setting in the VictronConnect app is configured to a voltage higher than the actual system voltage, it will result in overcharging the battery.

The solar charger automatically detects the battery voltage on the first install, and afterwards, the self-detection is disabled.

However, if the solar charger is moved from a 24V system to a 12V system, it may not recognise the system change. Consequently, it will continue charging with 24V battery charge voltages, while the connected battery is a 12V battery, leading to overcharging of the 12V battery.

To verify the "battery voltage" setting, use the VictronConnect app or a connected display. If the setting is incorrect, make sure to adjust it to the correct battery voltage.

### 8.7.2. Battery charge voltage settings too high

Batteries can be overcharged if the battery charge voltages are set too high.

Verify that all the battery charge voltages (absorption and float) are correctly configured to match the recommended voltages specified in the battery manufacturer's documentation.

### 8.7.3. Battery unable to deal with equalisation

When equalisation occurs, the battery charge voltage will be considerably high, and if the battery is unsuitable for equalisation, it may be overcharged.

It's essential to note that not all batteries can handle equalisation voltages. Check with the battery manufacturer to determine if the battery you are using requires a periodic equalising charge.

In general, sealed batteries and lithium batteries do not require equalisation and should not undergo the equalisation process.

### 8.7.4. Battery old, faulty or undersized

A battery that has reached the end of its service life or has been damaged due to improper use may be susceptible to overcharging.

A battery is comprised of multiple cells connected in series. In the case of an old or damaged battery, it's possible that one of these cells is no longer operational. During charging, the faulty cells will not accept charge, and the remaining cells will receive the broken cell's charge voltage, resulting in overcharging.

To address this issue, replace the battery. If the system includes multiple batteries, it's recommended to replace the entire battery bank rather than mixing batteries of different ages in one bank.

Determining the exact history of a battery during its lifetime can be challenging. The solar charger retains 30 days of battery voltage history. If the system has a battery monitor or is connected to the VRM portal, the battery voltages and cycle history can be accessed to assess the battery's overall health and whether it is nearing the end of its service life or has been misused.

Similar issues can arise if the battery is too small and charged with a significantly high current. The small battery will not be able to accept the total charge and will end up being overcharged.

#### Battery health check using battery monitor history data

<b>Step 1</b>	In the VictronConnect app, navigate to the battery monitor history screen. Or (if applicable) access the battery history via the VRM portal.	 <p><i>VictronConnect app showing battery monitor history</i></p>
<b>Step 2</b>	Determine the number of charge cycles and synchronisations. Both indicate how many charge cycles the battery underwent.	
<b>Step 2</b>	Determine the average discharge or cumulative energy drawn.	
<b>Step 3</b>	Refer to the battery data sheet to find out how many cycles at what average discharge the battery is capable of. Compare this with the battery history and determine if the battery is approaching the end of its service life.	
<b>Step 4</b>	Check if the battery has been completely discharged at any point. Total and very deep discharges can damage a battery. Examine the deepest discharge, the lowest battery voltage and the number of full discharges.	
<b>Step 5</b>	Check if the battery has been charged with a too-high voltage. A very high charge voltage can damage the battery. Review the maximum battery voltage and the high voltage alarms. Verify that the measured maximum voltage has not exceeded the battery manufacturer's recommendations.	

## 8.8. Solar charger not achieving full output

In addition to potential issues with the PV array, several other reasons can hinder the solar charger from reaching its full-rated output.

#### Reasons for the solar charger not reaching its full output:

- The PV array is too small. If the PV array's power rating is less than the solar charger's nominal power rating, the solar charger cannot output more power than the connected solar array can provide.
- The PV array is not reaching its maximum power rating. Refer to the [PV yield lower than expected \[53\]](#) subchapter.



- The PV array is a mix of different PV panel types or models. Only use solar panels that are of the same brand, type and model.
- Do not use optimisers. Nearly all optimisers contain an MPPT or other tracking mechanisms, which will interfere with the MPPT algorithm in the solar charger.
- The PV array is wrongly configured. For a detailed explanation of how to configure PV arrays and properly use MC4 splitters and MC4 combiners, see the "Solar panel" chapter in the [Wiring Unlimited Book](#).
- The solar charger's maximum PV output power is related to the battery voltage. Refer to the [Maximum output power relates to battery voltage \[54\]](#) subchapter.
- The solar charger's PV electric connections are burned or melted, or MC4 connectors have been insufficiently crimped. Refer to the [PV connections burned or melted \[54\]](#) subchapter.
- The solar charger temperature is above 40°C. Refer to the [Temperature above 40°C \[54\]](#) subchapter.
- The batteries are either full or nearly full, causing no further power to flow into them.
- There may be an issue with the battery. Refer to the [Batteries are not charged \[44\]](#) and [Batteries are undercharged \[49\]](#) chapters.

### 8.8.1. PV yield lower than expected

If the PV yield is not meeting expectations, start by checking the solar charger history in the VictronConnect app. Verify the total maximum power (Pmax) for each day and compare it with the array power.

To determine the potential solar yield per day for a specific PV array size in a particular geographical location, utilise the MPPT sizing calculator on the [solar charger product page](#).

#### List of reasons why the PV array may generate less power than expected:

- Low sun angle (morning or evening) or seasonal differences.
- Cloud cover or adverse weather conditions.
- Shading from trees or buildings.
- Dirty solar panels.
- Incorrect orientation or inclination of the solar panels.
- Broken or faulty solar panels.
- Issues with wiring, fuses, circuit breakers, or there is a cable voltage drop.
- Incorrect usage or malfunctioning splitters or combiners.
- Part of the PV array is not functioning correctly.
- The PV array is too small for the desired output.
- Mistakes in solar array configuration.
- The batteries may be too small or aging, resulting in a reduced capacity.



*VictronConnect app history Pmax reading.*

### 8.8.2. Maximum output power relates to battery voltage

The solar charger's output current is limited to its rated current, resulting in varying output power depending on the battery's voltage.

**For instance:**

In a 75/15 solar charger with a 15A output current rating, the power going into the battery will differ for a 12V battery and a 24V battery.

- For a 12V battery, this is  $15A \times 12V = 180W$ .
- For a 24V battery, this is  $15A \times 24V = 360W$ .

Thus, even though a 360W panel is connected to the solar charger, the output power into a 12V battery will be less than when connected to a 24V battery.

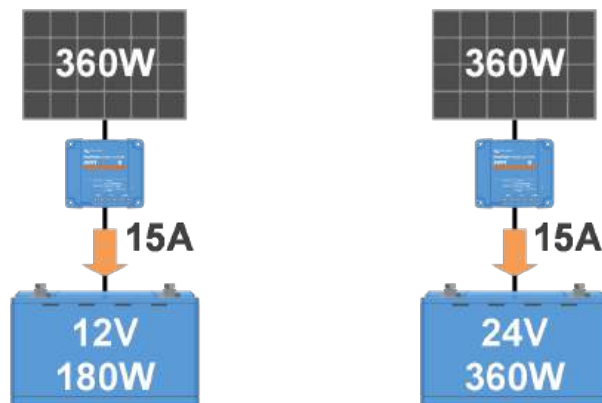

*Example of differences in output power at different battery voltages*

### 8.8.3. Temperature above 40°C

The solar charger operates up to 60°C, with full-rated output maintained up to 40°C. Above 40°C, the output will derate, reducing output power.

For efficient performance, consider the solar charger's mounting arrangement. Mount it vertically with terminals facing downwards to dissipate heat effectively. In closed enclosures, like cabinets, ensure proper airflow with mounted vents to allow cold air in and hot air out. In extremely high-temperature environments, mechanical air extraction or air conditioning may be necessary to maintain optimal performance.

### 8.8.4. PV connections burned or melted

Burned or melted PV cables or connections are not covered under warranty. This can occur due to the following reasons:

- Loose screw connections.
- Using cables with rigid core wire or rigid strands.
- Soldering the core wire ends of the cables.
- Using thin cables may result in higher currents when the PV voltage is lower. Refer to the [Wiring Unlimited book](#) for more information.
- Inserting cable insulation too deeply into the connector.
- Exceeding 30A per MC4 connector pair.
- Incorrectly crimping MC4 connectors.
- Using low-quality MC4 connectors.

## 8.9. Communication Issues

In this chapter, we address potential problems that may occur when connecting the solar charger to the VictronConnect app, other Victron devices, or third-party devices.

### 8.9.1. Bluetooth

Please note that Bluetooth interface issues are highly unlikely. If you encounter problems, they are probably caused by other factors. Use this chapter to quickly identify common causes of Bluetooth issues.

For a comprehensive troubleshooting guide, refer to the [VictronConnect manual](#).

Bluetooth check	
Step 1	<p><b>Check if the solar charger is powered up:</b></p> <ul style="list-style-type: none"> <li>• Observe the LEDs: If any LEDs are on, blinking, or pulsing with a few seconds interval, the unit is powered up, and Bluetooth should be functional.</li> <li>• If all LEDs are off, the unit is not powered up, and Bluetooth is inactive. Refer to the <a href="#">Solar charger is unresponsive [41]</a> chapter to troubleshoot.</li> </ul>
Step 2	<p><b>Check if the solar charger is equipped with Bluetooth:</b></p> <ul style="list-style-type: none"> <li>• Only SmartSolar models have built-in Bluetooth; BlueSolar models do not.</li> <li>• To add Bluetooth capability to a BlueSolar solar charger, use a VE.Direct Bluetooth Smart dongle. <a href="#">VE.Direct Bluetooth Smart dongle</a>.</li> </ul>
Step 3	<p><b>Check that Bluetooth is in range:</b></p> <ul style="list-style-type: none"> <li>• Bluetooth's maximum distance in open space is about 20 meters, but it may be lower inside buildings or vehicles.</li> </ul>
Step 4	<p><b>The Windows version of the VictronConnect app does not support Bluetooth:</b></p> <ul style="list-style-type: none"> <li>• Use an Android, iOS, or macOS device or connect using a <a href="#">VE.Direct to USB interface</a>.</li> </ul>
Step 5	<p><b>The solar charger is missing from the VictronConnect app device list:</b></p> <ul style="list-style-type: none"> <li>• Press the orange refresh button at the bottom of the device list.</li> <li>• Ensure no other devices are connected to the solar charger simultaneously.</li> <li>• Try connecting to another Victron product to rule out device-specific issues.</li> <li>• If still unresolved, refer to the <a href="#">VictronConnect app manual</a>.</li> </ul>
Step 6	<p><b>Lost PIN code:</b></p> <ul style="list-style-type: none"> <li>• Navigate to the VictronConnect app device list.</li> <li>• Click on the options symbol (3 dots) next to the solar charger listing.</li> <li>• Enter the solar charger's unique PUK code as printed on its product information sticker.</li> <li>• Reset the PIN code.</li> </ul>
Step 7	<p><b>Communication without Bluetooth:</b></p> <ul style="list-style-type: none"> <li>• If Bluetooth is unavailable, the VictronConnect app can still communicate via the unit's VE.Direct port or via the VRM portal (if connected to a GX device). Refer to the <a href="#">VictronConnect app [5]</a> chapter.</li> </ul>

### 8.9.2. VE.Direct port

Problems with the VE.Direct port are uncommon, but if encountered, they are likely due to the following issues:

#### Jumper in VE.Direct port

- The jumper is used to select the load output low voltage disconnect threshold and the "batteryLife" mode.
- If connecting a VE.Direct cable, remove the jumper and configure the load output via VictronConnect.
- In case the jumper is missing, configure the load output via VictronConnect.
- If a replacement jumper is needed, contact your Victron Energy dealer or distributor.

#### Physical cable connector or data port issue

- Try using a different VE.Direct cable to check if communication is established.
- Ensure the connector is inserted properly and fully into the port.
- Inspect the VE.Direct port for bent pins. If found, power the unit off by disconnecting it from the battery and the PV, and straighten the pins using long-nose pliers.

#### VE.Direct communication issues

- Connect the solar charger to a GX device to verify VE.Direct communication.
- Check if the solar charger appears in the GX device list.
- If it does not show up in the list, set the TX port function in VictronConnect to "Normal communication."

#### VE.Direct TX port issues

- Verify the "TX port function" setting in VictronConnect matches the intended application.
- Test the TX port's functionality using a [TX digital output cable](#).

#### VE.Direct RX Port issues

- Confirm the "RX port function" setting in VictronConnect aligns with the intended application.
- Test the RX port's functionality using a [VE.Direct non-inverting remote on/off cable](#).

### 8.9.3. VE.Smart Networking

A VE.Smart Network is a wireless communication network that connects multiple Victron products using Bluetooth. If you encounter any problems with a VE.Smart Network, please refer to [VE.Smart Networking manual](#).

## 8.10. Load output issues

If you encounter any issues with the load output, consider the following reasons that might explain why it is not functioning as expected:

#### • **Battery voltage threshold:**

The load output might be deactivated to safeguard the battery. This occurs if the battery voltage drops below the set threshold. Check the battery voltage and load output settings programmed via the jumper, the VictronConnect app, or the display. This behaviour is normal and not a cause for concern. Refer to the [Load output settings \[22\]](#) chapter for more information.

#### • **The (default) BatteryLife algorithm is active:**

The load output might be deactivated in certain situations to safeguard the battery. While, you would expect the load output to be active when looking at the battery voltage. Refer to the [BatteryLife \[8\]](#) chapter for more information.

#### • **Incorrect load output "Operation mode" setting:**

Ensure that the correct operation mode is selected in the VictronConnect app settings. Refer to the [Load output settings \[22\]](#) chapter. Note that the jumper must be removed when switching the load operation mode.

#### • **Load output has been permanently turned on or off:**

Ensure that the correct operation mode is selected in the VictronConnect app settings. Refer to the [Load output settings \[22\]](#) chapter.

#### • **Delay after a setting change:**

The load output might switch off temporarily when settings are changed. It can take up to 2 minutes before the load output becomes active again. This is expected behaviour.

#### • **The load output is not able to run a specific load:**

Refer to the [Load output not able to run load \[57\]](#) subchapter.

- **There is an incorrect load output current or power reading:**

Refer to the [Load output not able to run load \[57\]](#) subchapter.

### 8.10.1. Load output not able to run load

These are possible reasons why the solar charger load output might not be able to run a load:

- The load consumes excessive power

The connected load draws more power than the load output can supply. refer to the "Maximum continuous load current rating" in the [Technical specifications \[62\]](#) chapter.

Note that for the 100/20 model, if it is configured to 36V or 48V, the load output current rating is limited to 1A.

- The load has a high inrush current

Some loads with high inrush are best connected directly to the battery. In such cases, the load output controls the inverter using a remote on/off cable. Refer to the [Physical load output \[7\]](#) chapter for more information.

- The load presents as a short circuit.

The load output may experience a short circuit either due to a malfunctioning load or a wiring issue within the electric circuit connected to it. It's important to note that the solar charger will not get damaged in the event of a short circuit.

### 8.10.2. Incorrect load output current reading

To troubleshoot the load output reading check the following:

- **Correct current reading:**

Ensure an accurate load output reading by connecting all loads to the solar charger's positive and negative load terminals(image A).

- **Incorrect current reading:**

Do not connect the positive cable of the load to the load output and the negative cable to the battery (image B). This will result in an incorrect load current reading,

- **Bypassing the current reading:**

Certain large loads, especially inverters, are best connected directly to the battery. However, this can result in an incomplete load current reading since it will not account for the current flowing directly to the battery-connected load (image C).

To address this, consider adding a [battery monitor](#) to the system. The battery monitor will measure all currents entering or leaving the battery, including those directed to loads directly connected to the battery.

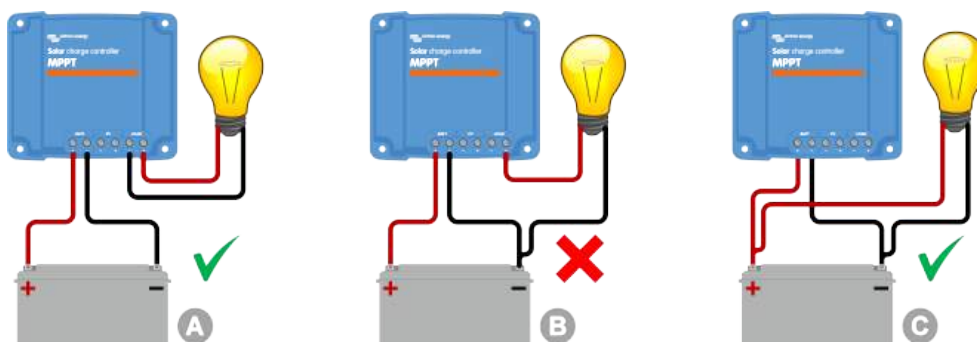

## 8.11. Miscellaneous issues

This chapter describes issues that were not covered in the previous troubleshooting chapter.

### 8.11.1. Only voltage readings, no current or power

This only applies to some 10A and 15A solar charger models.

If the solar charger only shows voltage readings and omits current and power readings, it indicates that the current monitoring is bypassed due to a potential PV negative being mistakenly connected to the battery negative.

To rectify this, make sure to connect the PV negative to its respective terminal instead of the battery negative.

### 8.11.2. Unable to select 36V or 48V battery voltage

Not all solar chargers support 36V or 48V battery system voltages.

To confirm the supported battery voltages, refer to the [Technical specifications \[62\]](#) chapter or check the "battery voltage" parameter drop-down menu in the VictronConnect app.

### 8.11.3. Unable to operate as a DC-DC charger or power supply

Avoid using the solar charger as a DC-DC charger (e.g., to charge a 12V battery from a 24V battery bank). Connecting a battery to the PV terminals under certain operational conditions can damage the solar charger, which is not covered by the warranty. Instead, use a dedicated DC-DC charger or converter. Check our [DC-DC converter product page](#) for a complete product range.

Also, refrain from using the solar charger as a power supply without batteries connected. Although this operation won't harm the solar charger, it might not support all types of loads. Some loads may function, while others may not, particularly at low load power, where the solar charger's response might be too slow to maintain a constant voltage. Please note that support is not provided for such situations.

### 8.11.4. Interrupted firmware update

An interrupted firmware update is recoverable and there is no need to worry. Simply attempt to update the firmware once more.

### 8.11.5. Ground current

If a ground current is detected in the system during normal operation, take the following steps:

- First, thoroughly inspect all the equipment connected to the system and check for any ground faults.
- Next, verify the number of connections to ground in the system. Ideally, there should be only one point in the system connected to the ground, which should be at the battery.
- For more information on system grounding, see the "System grounding" chapter in the [Wiring Unlimited book](#).

Note that the solar charger is non-isolated and the minus of the PV input is at the same potential as the minus of the battery output.

## 8.12. Error code overview

The error codes in the following subchapters are potentially displayed in the VictronConnect app, on a remote display or a connected GX device. For the most up-to-date error overview, see this link: <https://www.victronenergy.com/live/mppt-error-codes>.

Furthermore, the solar charger utilises specific LED indications to signal particular errors. For an overview of these LED codes, please refer to the [Victron Toolkit app](#).

### 8.12.1. Error 1 - Battery temperature too high

This error will auto-reset after the battery temperature has dropped. The solar charger will stop charging to prevent damaging the battery. The battery temperature can be received by an external sensor (like Smart Battery Sense or BMV) or measured by the charger when this feature is available.

### 8.12.2. Error 2 - Battery voltage too high

This error will auto-reset after the battery voltage has dropped. This error can be due to other charging equipment connected to the battery or a fault in the solar charger.

This error can also occur if the battery voltage (12, 24, 48V) is set to a lower voltage than the connected battery.

### 8.12.3. Error 17 - Solar charger overheated despite reduced output current

This error will auto-reset after the solar charger has cooled down. Check the ambient temperature and check for obstructions near the heat sink.

### 8.12.4. Error 18 - Solar charger over-current

This error will auto-reset. If the error does not auto-reset, disconnect the solar charger from all power sources, wait 3 minutes, and reconnect so it will power up again.

#### Possible causes for an over-current on the battery terminals:

- Switching on/off a very large load on the battery side.
- Sudden change in irradiance is causing a temporary over-power in the solar charger.
- Overload of the inverter ac output.

#### Possible solutions:

- If possible, provide adequate cooling for the unit. A cooler unit can handle more current.
- Reduce the load on the inverter.
- Charge the battery before using the inverter. At higher battery voltages, the same amount of power requires less current.

### 8.12.5. Error 20 - Maximum bulk time exceeded

The maximum bulk time protection was a feature when the solar chargers were newly released in 2015 (or prior). This feature has now been removed.

If you see this error, update the solar charger to the latest firmware. If, after the update, you still see this error, then perform a "reset to factory defaults" and then reconfigure the solar charger.

### 8.12.6. Error 21 - Current sensor issue

If you see this error, update the solar charger to the latest firmware. If, after the update, you still see this error, then perform a "reset to factory defaults" and then reconfigure the solar charger.

Disconnect all wires and then reconnect all wires to force the solar charger to restart. Also, make sure the minus on the solar charger (PV negative and battery negative) is not bypassing the solar charger.

This error will not auto-reset.

If the error remains, please contact your dealer or distributor, as there might be a hardware defect.

### 8.12.7. Error 26 - Terminal overheated

Power terminals overheated, check the wiring, including the wiring type and type of strands, and/or fasten bolts if possible.

This error will auto-reset.

### 8.12.8. Error 28 - Power stage issue

This error will not auto-reset.

Disconnect all wires, and then reconnect all wires. If the error persists, the charger is probably faulty.

Note that this error was introduced in v1.36. So when doing an update, it might look like the firmware update caused this issue; but it doesn't. The solar charger was then already not performing 100% before the update; updating to v1.36 or later merely made the issue more visible. The unit needs to be replaced.

### 8.12.9. Error 33 - PV over voltage

This error will auto-reset after the PV voltage has dropped to a safe limit.

This error is an indication that the PV array configuration with regard to open-circuit voltage is critical for this charger. Check configuration, and if required, re-organise panels.

For more information, refer to the [PV voltage too high \[48\]](#) chapter.

### 8.12.10. Error 38, 39 - PV Input shutdown

When these errors show, the PV Input is internally shorted to protect the battery from overcharging. Prior to any other troubleshooting, make sure to update to the latest firmware version.

#### Possible reasons for this error to occur:

- The "Battery voltage" parameter (12/24/36/48V) is set incorrectly. Use the VictronConnect app to set the correct "Battery voltage" parameter.
- Another device is connected to the battery, configured to a higher voltage. For example, an inverter/charger is configured to equalise at 17 Volts, while this is not configured in the solar charger.

#### Error recovery:

- Error 38: First, disconnect the solar panels and then disconnect the battery. Wait for 3 minutes, then first reconnect the battery and then the panels.
- Error 39: The charger will automatically resume operation once the battery voltage drops below its maximum voltage setting (normally Equalisation or Absorption voltages). It can also take a minute to reset the fault.
- If the error persists, the solar charger is probably faulty.

### 8.12.11. Error 40 - PV Input failed to shutdown

If the solar charger is unable to turn off the PV input, it will go into a safe mode in order to protect the battery from over-charging or having a high voltage on the battery terminals. In order to do that, the solar charger will stop charging and disconnect its own output. The solar charger will become faulty.

### 8.12.12. Error 80 to 88 - PV Input shutdown

When these errors show, the PV Input is internally shorted in order to protect the battery from over-charging.

Prior to any other troubleshooting, make sure to update to the latest firmware version.

#### Possible reasons for this error to occur:

- The "Battery voltage" (12, 24, 36 or 48V) parameter is set incorrectly. Use the VictronConnect app to set it to the correct battery voltage.
- Another device is connected to the battery with a higher charge voltage configuration. For instance, a MultiPlus is configured to equalise at 17V, while the solar charger has not been configured for equalise charging.

#### Error recovery:

- Ensure that the solar charger is running the latest firmware.
- Errors 80 to 83: First, disconnect the solar panels, then disconnect the battery and then follow the procedure as described in the [???](#) chapter.
- Errors 84 to 87: First, disconnect the solar panels and disconnect the battery. Wait for 3 minutes, then first reconnect the battery and then reconnect the panels.
- If the error persists, the solar charger is probably faulty.

### 8.12.13. Error 116 - Calibration data lost

If the unit does not work and error 116 pops up as the active error, the unit is faulty. Contact your dealer for a replacement.



If the error is only present in the history data and the unit operates normally this error can be ignored safely. Explanation: when the units power up for the very first time in the factory, it does not have calibration data and an error 116 is logged. Obviously, this should have been cleared, but in the beginning, units left the factory with this message still in the history data.

SmartSolar models (not the BlueSolar models): upgrading to v1.4x firmware is a one-way trip, you cannot go back to an older firmware version once you upgrade to v1.4x. Reverting to older firmware gives error 116 (calibration data lost), this can be fixed by re-installing the v1.4x firmware.

#### 8.12.14. Error 117 - Incompatible firmware

This error indicates that a firmware update did not complete, so the device is only partially updated. Possible causes are: the device was out of range when updating over the air, a cable got disconnected or power was lost during the update session.

To fix this the update needs to be retried, download the correct firmware for your device from the [Victron Professional Portal](#)

When your GX device is connected to VRM, you can do a remote firmware update using this firmware file. You can do this via the VRM website or using the VRM tab in VictronConnect. VictronConnect can also be used together with the firmware file to update using a Bluetooth connection.

The procedure to add the file to VictronConnect and start the update is described here: [9. Firmware updates](#)

#### 8.12.15. Error 119 - Settings data lost

The charger cannot read its configuration and has stopped. This error will not auto-reset.

Perform the below procedure to get it working again:

**Error recovery:**

- First, restore it to factory defaults. (top right in Victron Connect, click on the three dots).
- Disconnect the solar charger from all power sources.
- Wait 3 minutes, and power up again.
- Reconfigure the charger.
- Report this to your Victron dealer and ask for it to be escalated to Victron; as this error should never happen. Preferably include firmware version and any other specifics (VRM URL, VictronConnect screenshots or similar).

## 9. Technical specifications

### 9.1. Specifications 75/10, 75/15, 100/15 and 100/20

	MPPT 75/10	MPPT 75/15	MPPT 100/15	MPPT 100/20
Battery voltage (auto select)	12V or 24V			12V, 24V, or 48V
Maximum battery current	10A	15A	15A	20A
Nominal PV power, 12V <sup>1a,b</sup>	145W	220W	220 W	290W
Nominal PV power, 24V <sup>1a,b</sup>	290W	440W	440 W	580W
Nominal PV power, 48V <sup>1a,b</sup>	-	-	-	1160W
Max. PV short circuit current <sup>2</sup>	10A	15A	15A	20A
Automatic load disconnect	Yes			
Maximum PV open circuit voltage	75V		100V	
Peak efficiency	98%			
Self consumption	12V: 20mA / 24V: 10mA			12V: 25mA 24V / 48V: 15mA
Charge voltage 'absorption'	14.4V / 28.8V / 57.6V (adjustable)			
Charge voltage 'float'	13.8V / 27.6V / 55.2V (adjustable)			
Charge voltage 'equalization' <sup>3</sup>	16.2V / 32.4V / 64.8V (adjustable)			
Charge algorithm	Multi-stage adaptive or user defined algorithm			
Temperature compensation	12V: -16mV/°C / 24V: -32mV/°C / 48V: -64 mV/°C			
Continuous load current	15A			12V & 24V: 20A 48V: 1A
Low voltage load disconnect	11.1V / 22.2V / 44.4V or 11.8V / 23.6V / 47.2V or BatteryLife algorithm			
Low voltage load reconnect	13.1V / 26.2V / 52.4V or 14V / 28V / 56V or BatteryLife algorithm			
Protection	PV reverse polarity, output short circuit, over temperature			
Operating temperature	-30°C to +60°C (full rated output up to 40°C)			
Humidity	100%, non-condensing			
Maximum altitude	5000m (full rated output up to 2000m)			
Environmental condition	Indoor type 1, unconditioned			
Pollution degree	PD3			
Data communication	VE.Direct port <sup>4</sup>			
<b>ENCLOSURE</b>				
Colour	Blue (RAL 5012)			
Power terminals	6mm <sup>2</sup> / AWG10			
Protection category	IP43 (electronic components), IP22 (connection area)			
Weight	0.5kg		0.6kg	0.65kg
Dimensions (h x w x d)	100 x 113 x 40mm		100 x 113 x 50mm	100 x 131 x 60mm
<b>STANDARDS</b>				
Safety	EN/IEC 62109-1 / UL 1741 / CSA C22.2 NO.107.1-16			

	MPPT 75/10	MPPT 75/15	MPPT 100/15	MPPT 100/20
1a)	The solar charger will limit input power if more PV power is connected.			
1b)	The PV voltage must exceed $V_{bat} + 5V$ for the controller to start. Thereafter the minimum PV voltage is $V_{bat} + 1V$ .			
2)	A higher short circuit current may damage the solar charger in case of reverse polarity connection of the PV array.			
3)	Equalization is by default disabled.			
4)	For more information on data communication see the <a href="#">data communication paper</a> in the <a href="#">Technical information section</a> on our website.			

## 9.2. Dimension drawings

### 9.2.1. Dimensions 75/10 and 75/15

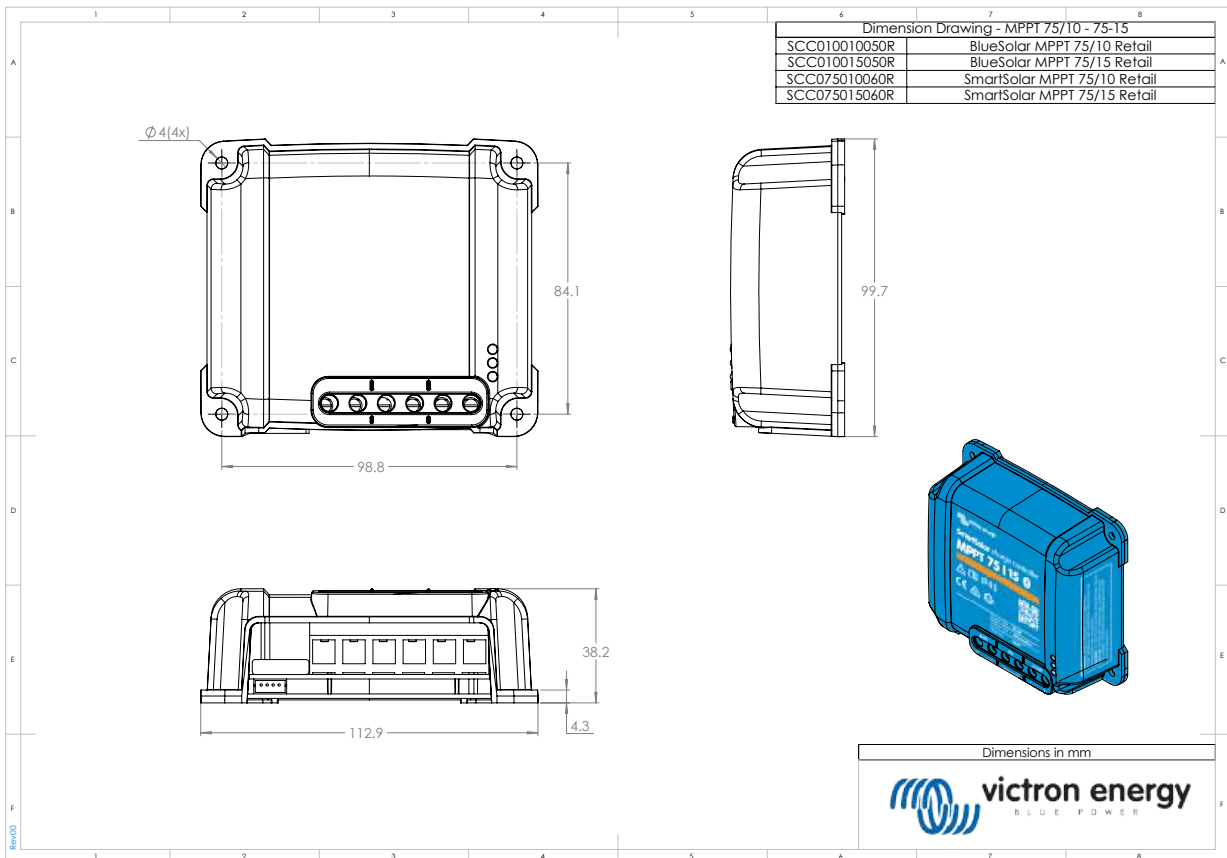

### 9.2.2. Dimensions 100/15

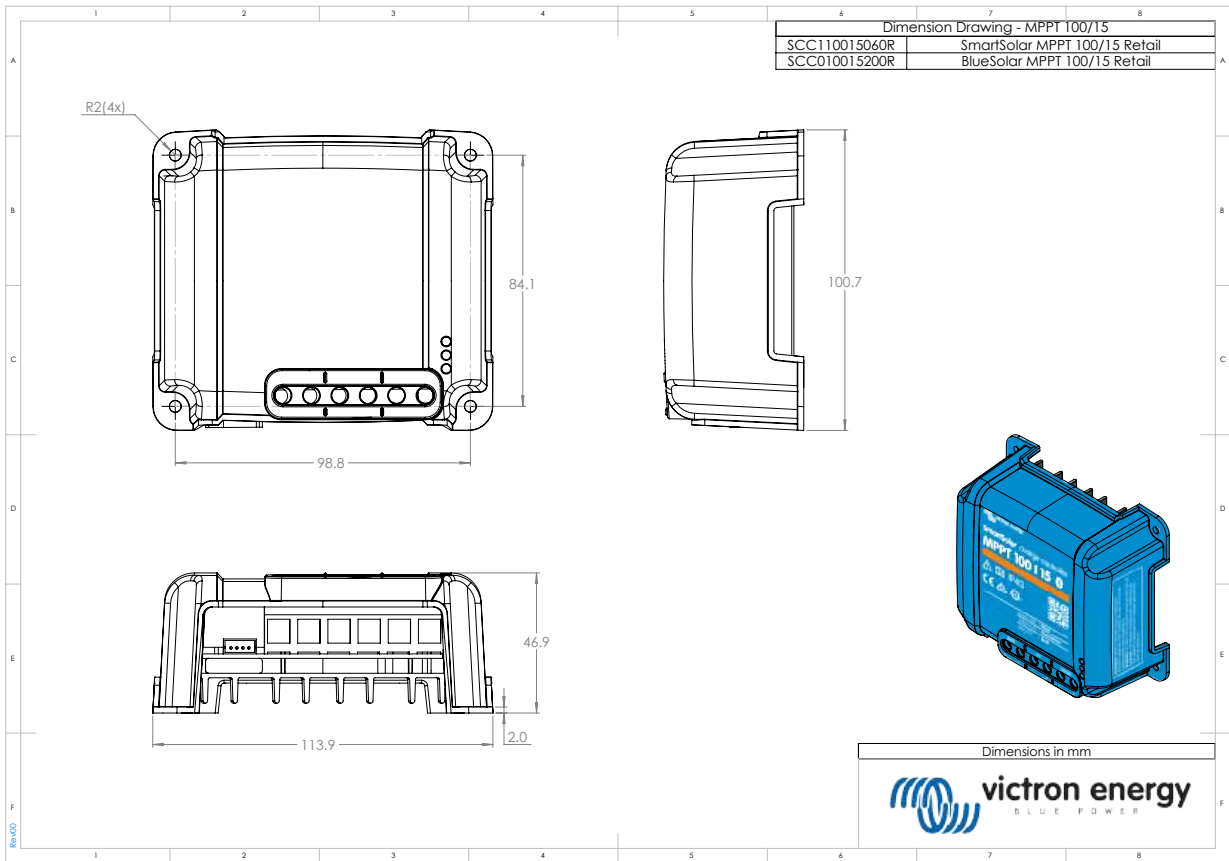

### 9.2.3. Dimensions 100/20

